

**CHAPTER 15**

**PO 340 – IDENTIFY ASPECTS OF SPACE EXPLORATION**





**ROYAL CANADIAN AIR CADETS**  
**PROFICIENCY LEVEL THREE**  
**INSTRUCTIONAL GUIDE**



**SECTION 1**

**EO M340.01 – IDENTIFY CANADIAN ASTRONAUTS**

---

Total Time: 30 min

---

**PREPARATION**

---

**PRE-LESSON INSTRUCTIONS**

Resources needed for the delivery of this lesson are listed in the lesson specification located in A-CR-CCP-803/PG-001, Chapter 4. Specific uses for said resources are identified throughout the instructional guide within the TP for which they are required.

Review the lesson content and become familiar with the material prior to delivering the lesson.

Choose two astronauts to be the focus of this lesson.

Retrieve current information about the chosen astronauts from the annexes and update with information from the reference.

Create a slide of each astronaut's photograph.

**PRE-LESSON ASSIGNMENT**

N/A.

**APPROACH**

An interactive lecture was chosen for this lesson to orient the cadets to Canadian astronauts, to generate interest in Canada's space program, and to emphasize the teaching points.

---

**INTRODUCTION**

---

**REVIEW**

N/A.

**OBJECTIVES**

By the end of this lesson the cadet shall have identified Canadian astronauts.

**IMPORTANCE**

It is important for cadets to identify Canadian astronauts so that they can become familiar with the Canadian space program. The hard work that astronauts perform will illustrate the Air Force motto: Per Ardua ad Astra, as well as the rewards that can be achieved by men and women who accept the challenge of the stars.

---

**Teaching Point 1****Identify Canadian Astronauts**

Time: 10 min

Method: Interactive Lecture

---

Training of Canada's astronauts began in 1983 and Canada's first astronaut, Marc Garneau, visited space in October 1984, when, among many other mission accomplishments, the Canada Experiment (CANEX) payload performed important experiments. Those early CANEX experiments were:

- Auroral Photography Experiment (APE),
- Radiation Monitoring Equipment (RME), and
- Thermoluminescent Dosimeter (TLD).

Since that time both the astronaut cadre and Canada's space program have grown. Some astronauts have retired after brilliant careers and new members have joined the team. Some of Canada's astronauts include:

- Marc Garneau (Canada's first astronaut),
- Roberta Bondar (Canada's first woman astronaut),
- Steve MacLean,
- Chris Hadfield,
- Robert Thirsk,
- Bjarni Tryggvason,
- David Williams, and
- Julie Payette.



Show the cadets the slides of photographs located at Annexes A to H.



Using information retrieved from the reference, identify the Canadian astronaut who most recently made his or her first space journey.

---

**CONFIRMATION OF TEACHING POINT 1**

---

**QUESTIONS**

- Q1. In what year did training of Canada's astronauts begin?
- Q2. When did Canada's first astronaut visit space?
- Q3. Who was Canada's first astronaut?

**ANTICIPATED ANSWERS**

- A1. 1983.  
 A2. October 1984.  
 A3. Marc Garneau.

**Teaching Point 2****Discuss the Professional and Personal Profiles of Two Canadian Astronauts**

Time: 15 min

Method: Interactive Lecture



Discuss the following information about the two chosen astronauts, using information located at the respective annexes or retrieved from the reference, to include:

- a. missions undertaken,
- b. place and date of birth,
- c. education,
- d. professional experience,
- e. special honours, and
- f. affiliations.

**CONFIRMATION OF TEACHING POINT 2****QUESTIONS**

- Q1. In what missions did these astronauts take part?  
 Q2. What part did these astronauts play on these missions?  
 Q3. What education and experience did these astronauts bring to the missions?

**ANTICIPATED ANSWERS**

- A1. As per lesson content in TP 2.  
 A2. As per lesson content in TP 2.  
 A3. As per lesson content in TP 2.

**END OF LESSON CONFIRMATION****QUESTIONS**

- Q1. Which Canadian astronaut most recently made his or her first space journey?  
 Q2. Who was Canada's first astronaut?  
 Q3. Who was Canada's first woman astronaut?

### **ANTICIPATED ANSWERS**

- A1. As per lesson content in TP 1.
- A2. Marc Garneau.
- A3. Roberta Bondar.

---

### **CONCLUSION**

---

### **HOMEWORK/READING/PRACTICE**

N/A.

### **METHOD OF EVALUATION**

N/A.

### **CLOSING STATEMENT**

Space missions have a short history and a vast future. Cadets can stay current with the space program by frequently visiting websites of the Canadian Space Agency (CSA), the US National Aeronautics and Space Administration (NASA) and websites of other organizations such as the European Space Agency (ESA).

### **INSTRUCTOR NOTES/REMARKS**

The instructor shall obtain the latest biographical information for this EO. This material must be updated each year to reflect the Canadian Space Agency's recent activities.

A list shall be kept of astronauts that cadets have focused on to prevent repetition, since other lessons, such as EO C340.01 (Identify Canadian Astronauts, Section 3), may introduce other astronauts in the future.

---

### **REFERENCES**

---

- C3-238 Canadian Space Agency. (2008). *Canadian Space Agency*. Retrieved February 9, 2008, from <http://www.space.gc.ca/asc/eng/default.asp>.



**ROYAL CANADIAN AIR CADETS**  
**PROFICIENCY LEVEL THREE**  
**INSTRUCTIONAL GUIDE**



**SECTION 2**

**EO M340.02 – DISCUSS THE HISTORY OF MANNED SPACE EXPLORATION**

---

Total Time: 30 min

---

**PREPARATION**

---

**PRE-LESSON INSTRUCTIONS**

Resources needed for the delivery of this lesson are listed in the lesson specification located in A-CR-CCP-803/PG-001, Chapter 4. Specific uses for said resources are identified throughout the instructional guide within the TP for which they are required.

Review the lesson content and become familiar with the material prior to delivering the lesson.

Create slides of figures located at Annexes I to L.

**PRE-LESSON ASSIGNMENT**

N/A.

**APPROACH**

An interactive lecture was chosen for this lesson to orient the cadets, generate interest, present background material, and clarify the history of manned space exploration.

---

**INTRODUCTION**

---

**REVIEW**

N/A.

**OBJECTIVES**

By the end of this lesson the cadet shall have discussed the history of manned space exploration.

**IMPORTANCE**

It is important for cadets to learn about the history of manned space exploration because in the near future, space exploration will become increasingly significant as developing technologies and resource depletion move humanity's focus beyond earth.

**Teaching Point 1****Discuss the Mercury Program**

Time: 5 min

Method: Interactive Lecture



Show the cadets the early manned space exploration timeline located at Annex I.

On May 5, 1961, America's first astronaut, Alan Shepard, blasted into space on a Redstone rocket. His history-making suborbital flight was in a one-man capsule named Freedom 7, which was only two metres long and less than two metres in diameter.



Show the cadets Figure 15I-1.

**OBJECTIVES OF THE MERCURY PROGRAM**

Specific studies and tests conducted by the US government and industry, culminating in 1958, indicated the feasibility of manned space flight. The objectives of the Mercury program, as stated at the time of project commencement in November 1958, were:

- place a manned spacecraft in orbital flight around the earth;
- investigate man's performance capabilities and his ability to function in the environment of space; and
- recover the man and the spacecraft safely.



The 1983 movie *The Right Stuff* is based on the story of the Mercury program.

**HISTORY OF THE MERCURY PROGRAM**

The US' first manned space flight project was successfully accomplished in less than five years, which saw more than 2 000 000 people from major government agencies and the aerospace industry combine their skills, initiative and experience into a national effort.

In this period, six manned space flights were accomplished as part of a 25-flight program. These manned space flights were accomplished with complete pilot safety and without change to the basic Mercury objectives.

It was shown that man could function ably as a pilot-engineer-experimenter without undesirable reactions or deteriorations of normal body functions for periods up to 34 hours of weightless flight. Directing this large and fast moving project required the development of a management structure and operating mode that satisfied the requirement to mould the many different entities into a workable structure.

**Timeline of the Mercury Program**

- October 1, 1958 National Aeronautics and Space Administration (NASA) created



- November 26, 1958 Mercury program announced
- December 4, 1959 Launch of Sam (a monkey) on Little Joe 2
- April 9, 1959 NASA names the seven Mercury astronauts
- January 21, 1960 Launch of Miss Sam (a monkey) on Little Joe IB
- January 31, 1961 Launch of Ham (a chimpanzee) on Mercury Redstone 2
- May 5, 1961 Launch of Alan Shepard in Freedom 7 (suborbital)
- July 21, 1961 Launch of Gus Grissom in Liberty 7 (suborbital)
- November 29, 1961 Launch of Enos (a chimpanzee) on Mercury Atlas 5 (orbital)
- January 3, 1962 Gemini program formally conceived
- February 20, 1962 Launch of John Glenn in Friendship 7, first American human orbital flight
- May 24, 1962 Launch of Scott Carpenter in Aurora 7
- October 3, 1962 Launch of Walter Schirra in Sigma 7
- May 15, 1963 Launch of Gordon Cooper in Faith 7, the final mission of the Mercury program

---

### CONFIRMATION OF TEACHING POINT 1

---

#### QUESTIONS

- Q1. Who was America's first astronaut to go into space?
- Q2. Which movie portrays the Mercury program?
- Q3. How many manned missions were there in the Mercury program?

#### ANTICIPATED ANSWERS

- A1. Alan Shepard.
- A2. *The Right Stuff*.
- A3. Six.

---

#### Teaching Point 2

Time: 5 min

#### Discuss the Gemini Program

Method: Interactive Lecture

---



Show the cadets the early manned space exploration timeline located at Annex I.

#### OBJECTIVES OF THE GEMINI PROGRAM

The Gemini program was a necessary intermediate step between the Mercury program and the Apollo program. It had four objectives:

- to subject astronauts to long duration flights – a requirement for projected later trips to the moon or deeper space;
- to develop effective methods for rendezvous and docking with other orbiting vehicles and to manoeuvre the docked vehicles in space;
- to perfect methods of re-entry and landing spacecraft at a pre-selected ground landing point; and
- to gain additional information concerning the effects of weightlessness on crew members and to record the physiological reactions of crew members during longer duration flights.

## HISTORY OF THE GEMINI PROGRAM

On May 25, 1961, three weeks after Mercury astronaut Alan Shepard became the first American in space, President John F. Kennedy announced the goal to send astronauts to the moon before the end of the decade. To facilitate this goal, NASA expanded the existing manned space flight program in December 1961 to include the development of a two-man spacecraft. The program was officially designated Gemini on January 3, 1962.

Gemini, to a large degree, was the work of a Canadian – James Arthur Chamberlin of Kamloops, British Columbia, a mechanical engineer educated at the University of Toronto. Having served as the chief engineer for the Mercury program, Chamberlin was selected to be Gemini's Project Manager.



Show the cadets Figure 15J-1.

Gemini was named after the third constellation of the Zodiac and its twin stars, Castor and Pollux, because of its two-man crew.



Show the cadets Figure 15J-2.

Gemini consisted of 12 flights, including two unmanned flight tests of the equipment:

- March 23, 1965                      [Gemini III](#) – First manned Gemini flight completed three orbits
- June 03–07, 1965                  [Gemini IV](#) – First American Extravehicular Activity (EVA)
- August 21–29, 1965                [Gemini V](#) – First use of fuel cells for electrical power
- December 04–18, 1965            [Gemini VII](#) – First rendezvous in space, with Gemini VI-A
- December 15–16, 1965            [Gemini VI-A](#) – First rendezvous in space, with Gemini VII



Show the cadets Figure 15J-3.

- March 16, 1966 [Gemini VIII](#) – First docking with another (unmanned) spacecraft by astronauts Neil Armstrong and David Scott
- June 03–06, 1966 [Gemini IX-A](#) – Three rendezvous and two hours of EVA
- July 18–21, 1966 [Gemini X](#) – Rendezvoused with target vehicle and EVA
- September 12–15, 1966 [Gemini XI](#) – Gemini record altitude of 1 189.3 km
- November 11–15, 1966 [Gemini XII](#) – Final Gemini flight: rendezvous, docking, EVA

---

## CONFIRMATION OF TEACHING POINT 2

---

### QUESTIONS

- Q1. Who was the Gemini Project Manager?
- Q2. How many astronauts were on a Gemini flight?
- Q3. Which astronauts accomplished the first docking with another space vehicle?

### ANTICIPATED ANSWERS

- A1. James Arthur Chamberlin of Kamloops, British Columbia.
- A2. Two.
- A3. The Gemini crew of [Neil Armstrong](#) and [David Scott](#).

---

### Teaching Point 3

### Discuss the Apollo Program

Time: 5 min

Method: Interactive Lecture

---



Show the cadets the early manned space exploration timeline located at Annex I.

July 20, 1969: “Houston, Tranquility Base here. The Eagle has landed.” were the famous first words spoken from the moon.

### OBJECTIVES OF THE APOLLO PROGRAM

The Apollo’s program objectives went beyond landing Americans on the moon and returning them safely to earth. The objectives also included:

- establishing the technology to meet other national interests in space;
- achieving pre-eminence in space for the United States;
- carrying out a program of scientific exploration of the moon; and
- developing man’s capability to work in the lunar environment.

## HISTORY OF THE APOLLO PROGRAM

The Apollo program was the work of Owen E. Maynard of Sarnia, Ontario, chief of the systems engineering division in the Apollo Spacecraft Program Office. He was previously chief of the Lunar Module engineering office in the Apollo Program Office at the Manned Spacecraft Center in Houston. Maynard held an aeronautical engineering degree from the University of Toronto. His years at NASA were rewarded on July 20, 1969, when Apollo 11 commander Neil Armstrong stepped out of the lunar module (LM) and took one small step in the Sea of Tranquility, calling it a giant leap for mankind. Maynard remained in charge of Apollo systems engineering until he left NASA in 1970 following the successful achievement of Kennedy's lunar landing goal. Thereafter he returned to private industry.



Show the cadets Figure 15K-1.

The Apollo program used the Saturn family of launch vehicles. The command, service and lunar module made a small package, dwarfed at the top of the giant launch vehicle.



Show the cadets Figure 15K-2.

The command module (CM) was small for three men to spend 8 days, 3 hours and 18 minutes in it. On the *Apollo 11* journey of July, 1969, the three men were Neil Armstrong (commander), Michael Collins (CM pilot) and Edwin (Buzz) Aldrin Jr. (LM pilot).



Show the cadets Figure 15K-3.

Six of the Apollo missions, *Apollo 11, 12, and 14–17*, landed on the moon, studying soil mechanics, meteoroids, seismic activity, heat flow, lunar ranging, magnetic fields and solar wind.

*Apollo 7 and 9* tested spacecraft in earth orbit; *Apollo 10* orbited the moon as the dress rehearsal for the first landing. An oxygen tank explosion forced *Apollo 13* to scrub its landing, but the can-do problem-solving of the crew and mission control – and Maynard's systems engineering group – turned the mission into what was called a successful failure.



The 1995 movie *Apollo 13* is based on the story of the 1970 mission to the moon.

### Apollo Flight Summary

- October 1968 *Apollo 7* – Earth orbit

- December 1968 *Apollo 8* – Ten lunar orbits
- March 1969 *Apollo 9* – First manned flight of lunar module
- May 1969 *Apollo 10* – Dress rehearsal for Moon landing
- July 20 1969 *Apollo 11* – First lunar landing mission (on the Sea of Tranquility)
- November 1969 *Apollo 12* – Second lunar landing (on the Ocean of Storms)
- April 1970 *Apollo 13* – Mission aborted after an on-board explosion
- January 1971 *Apollo 14* – Third lunar landing (at Fra Mauro)
- July 1971 *Apollo 15* – Fourth lunar landing (in the Hadley Apennine region)
- April 1972 *Apollo 16* – Fifth lunar landing (on the Descartes highlands)
- December 1972 *Apollo 17* – Last lunar landing (on the Taurus Littrow highlands)

---

### CONFIRMATION OF TEACHING POINT 3

---

#### QUESTIONS

- Q1. Which family of launch vehicles were used for Project Apollo?
- Q2. Who was chief of systems engineering for the Apollo Project?
- Q3. What was the date of Apollo's first manned moon landing?

#### ANTICIPATED ANSWERS

- A1. The Saturn family.
- A2. Owen E. Maynard of Sarnia, Ontario.
- A3. July 20, 1969.

---

#### Teaching Point 4

#### Discuss the Russian Manned Space Program

Time: 10 min

Method: Interactive Lecture

The Mir space station, which was shared by Russian cosmonauts and American astronauts, was a continuation of the Soviet space program. Construction of Mir began in 1986, before the Soviet Union was disbanded. Mir was preceded by many years of Soviet space development which included, among many other programs, the Vostok missions, the Soyuz missions and the Salyut space station.

#### VOSTOK

The Vostok program (Восток, translated as "East") was a Soviet human spaceflight project that succeeded in putting a person into earth's orbit for the first time.



Show the cadets Figure 15L-1.

Vostok manned record-breaking flights included:

- April 12, 1961 *Vostok-1* – First man in space (Yuri Gagarin)
- August 6, 1961 *Vostok-2* – First full day in space
- August 11, 1962 *Vostok-3* – First of two simultaneous manned spacecraft
- August 12, 1962 *Vostok-4* – Second of two simultaneous manned spacecraft
- June 14, 1963 *Vostok-5* – Longest solo orbital flight
- June 16, 1963 *Vostok-6* – First woman in space (Valentina Tereshkova)

## **SOYUZ**

The Soyuz program (meaning “Union”) is a human spaceflight program that was initiated by the Soviet Union in the early 1960s. It was originally part of a moon landing program intended to put a Soviet cosmonaut on the moon. Both the Soyuz spacecraft and the Soyuz launch vehicle were part of this program, which later became the responsibility of the Russian Federal Space Agency.

The Soyuz program produced many experimental variants, but its development is commonly divided into three historical parts:

- Early era: *Soyuz-1 to Soyuz-9* (1966–1970),
- Salyut era: *Soyuz-10 to Soyuz T-14* (1971–1985), and
- Mir era: *Soyuz T-15 to Soyuz TM-30* (1986–2000).

Unlike the one-man Vostok spacecraft, the first three-seat Soyuz was able to conduct active manoeuvring, orbital rendezvous and docking. These features would all have been necessary for a flight around the moon or for a lunar expedition. In the early plans for circumlunar flight, the Soyuz was to be a three-part spacecraft assembled in the low-earth orbit from parts delivered by separate launch vehicles. This plan was later abandoned in favour of a two-launch and, later, a single-launch method.

In 1971, a three-seat Soyuz delivered two crews to the first Salyut space station. Disaster struck when the first Salyut crew returned from orbit. The sudden depressurization of the re-entry capsule killed all three cosmonauts. As a result of this tragedy, the designers introduced protective pressure suits, but at the expense of room for one crewmember. Two-seat Soyuz spacecraft then continued ferrying the crews to the Salyut and Almaz space stations.

## **SALYUT AND MIR SPACE STATIONS**

### **First-Generation Salyut Stations (1964–1977)**

First-generation Salyut space stations had one docking port and could not be resupplied or refuelled. The stations were launched unmanned and later occupied by crews. There were two types: Almaz military stations and Salyut civilian stations. To Western observers, both types were Salyut stations, including:

- 1971 *Salyut-1* – First space station (civilian)
- 1973 *Salyut-2* – First Almaz station (military, failure)
- 1974–75 *Salyut-3* – Almaz station (military)
- 1974–77 *Salyut-4* – Civilian space station
- 1976–77 *Salyut-5* – Last Almaz station (military)



Show the cadets Figures 15L-2 and 15L-3.

### Second-Generation Stations (1977–1985)

Second-generation Russian space stations included:

- 1977–1982 *Salyut-6* – Civilian
- 1982–1991 *Salyut-7* – Civilian (last staffed in 1986)

With the second-generation stations, the Soviet space station program evolved from short-duration to long-duration stays. Visiting crews relieved the monotony of a long stay in space.

#### Salyut-6 Key Facts

Highlights of the *Salyut-6* era include:

- The station received 16 cosmonaut crews, including six long-duration crews. The longest stay time for a *Salyut-6* crew was 185 days. The first *Salyut-6* long-duration crew stayed in orbit for 96 days, beating the 84-day world record for space endurance established in 1974 by the last American Skylab crew.
- The station hosted cosmonauts from Hungary, Poland, Romania, Cuba, Mongolia, Vietnam and East Germany.
- Twelve freighter spacecraft delivered equipment, supplies and fuel.



Show the cadets Figure 15L-3 and 15L-4.

#### Salyut-7 Key Facts

Highlights of the *Salyut-7* era include:

- *Salyut-7*, a near twin of *Salyut-6*, was home to 10 cosmonaut crews, including six long-duration crews. The longest stay time was 237 days.
- Cosmonauts from France and India worked aboard the station, as did the first female Russian space traveller since 1963.
- Thirteen freighter spacecraft delivered equipment, supplies, and fuel to *Salyut-7*.
- Two experimental transport logistics spacecraft, Cosmos 1443 and Cosmos 1686, docked with *Salyut-7*. Cosmos 1686 was a transitional vehicle, a transport logistics spacecraft redesigned to serve as an experimental space station module.
- *Salyut-7* was abandoned in 1986 and re-entered earth's atmosphere, burning up over Argentina in February, 1991.

## Mir

*Mir* was a third-generation Russian space station which, after 1992, was shared with the US.

*Mir* means peace and community in Russian. The *Mir* space station contributed to world peace by hosting international scientists and American astronauts. It also supported a community of humans in orbit and symbolized the commonwealth of the Russian people.

*Mir* was constructed in orbit by connecting different modules, each launched separately from 1986 – 1996. During the Shuttle-Mir Program, Russia's *Mir* combined its capabilities with America's space shuttles. The orbiting *Mir* provided a large and liveable scientific laboratory in space. The visiting space shuttles provided transportation and supplies, as well as temporary enlargements of living and working areas, creating history's largest spacecraft.



Show the cadets Figures 15L-5 and 15L-6.

Magnificent to behold through the windows of a space shuttle, *Mir* was as big as six school buses. Inside, it looked more like a cramped labyrinth, crowded with hoses, cables and scientific instruments – as well as articles of everyday life, such as photos, children's drawings, books and a guitar. *Mir* commonly housed three crew members, but it supported as many as six, for up to a month. Except for two short periods, *Mir* was continuously occupied until August 1999.

The journey of the 15-year-old Russian space station ended March 23, 2001, as *Mir* re-entered the Earth's atmosphere near Nadi, Fiji and fell into the South Pacific. Despite its inconveniences, many cosmonauts and astronauts grew to love *Mir*, comparing it to a living being with qualities, needs and eccentricities.

---

### CONFIRMATION OF TEACHING POINT 4

---

#### QUESTIONS

- Q1. Which Salyut space stations were considered to be second generation?
- Q2. What does *Mir* mean in Russian?
- Q3. Who were the first man and woman in space?

#### ANTICIPATED ANSWERS

- A1. *Salyut-6* and *Salyut-7*.
- A2. Peace and community.
- A3. Yuri Gagarin and Valentina Tereshkova, respectively.

---

### END OF LESSON CONFIRMATION

---

#### QUESTIONS

- Q1. Who was America's first astronaut to go into space?
- Q2. When did *Apollo 11* land on the moon?



Q3. Who was chief of systems engineering for the Apollo Project?

**ANTICIPATED ANSWERS**

A1. Alan Shepard.

A2. July 20, 1969.

A3. Owen E. Maynard of Sarnia, Ontario.

---

**CONCLUSION**

---

**HOMEWORK/READING/PRACTICE**

N/A.

**METHOD OF EVALUATION**

N/A.

**CLOSING STATEMENT**

Space exploration has taken great courage and ingenuity on the part of many people. Space exploration and the space race have changed the world for the better through international cooperation and promoting technological advancement.

**INSTRUCTOR NOTES/REMARKS**

N/A.

---

**REFERENCES**

---

(ISBN 978-0-75662-227-5) Graham, I. (2006). *Space Travel*. New York, NY: DK Publishing, Inc.

THIS PAGE INTENTIONALLY LEFT BLANK



**ROYAL CANADIAN AIR CADETS**  
**PROFICIENCY LEVEL THREE**  
**INSTRUCTIONAL GUIDE**



**SECTION 3**

**EO C340.01 – IDENTIFY CANADIAN ASTRONAUTS**

---

Total Time:	60 min
-------------	--------

---

**PREPARATION**

---

**PRE-LESSON INSTRUCTIONS**

Resources needed for the delivery of this lesson are listed in the lesson specification located in A-CR-CCP-803/PG-001, Chapter 4. Specific uses for said resources are identified throughout the instructional guide within the TP for which they are required.

Review the lesson content and become familiar with the material prior to delivering the lesson.

Retrieve current information located at Annexes A to H in the instructional guide for EO M340.01 (Identify Canadian Astronauts, Section 1) or from the reference.

Create a slide of each astronaut's photograph from the same annexes.

**PRE-LESSON ASSIGNMENT**

N/A.

**APPROACH**

An interactive lecture was chosen for this lesson to orient the cadets to Canadian astronauts, to generate interest in Canada's space program, and to emphasize the teaching points.

---

**INTRODUCTION**

---

**REVIEW**

N/A.

**OBJECTIVES**

By the end of this lesson the cadet shall have identified Canadian astronauts.

**IMPORTANCE**

It is important for cadets to identify Canadian astronauts so that they can become familiar with the Canadian space program. The hard work that astronauts perform will illustrate the Air Force motto: *Per Ardua ad Astra*, as well as the rewards that can be achieved by men and women who accept the challenge of the stars.

---

**Teaching Point 1**

**Discuss the Professional and Personal Profiles of Canadian Astronauts**

Time: 50 min

Method: Interactive Lecture

---



Ensure that astronauts covered in EO M340.01 (Identify Canadian Astronauts, Section 1) are not included in this lesson.

Discuss the following information about the remaining astronauts, using the information located at the respective annexes in the instructional guide for EO M340.01 (Identify Canadian Astronauts, Section 1) or retrieved from the reference, to include:

- a. missions undertaken,
- b. place and date of birth,
- c. education,
- d. professional experience,
- e. special honours, and
- f. affiliations.

---

**CONFIRMATION OF TEACHING POINT 1**

---

The cadets' participation in the interactive lecture will serve as the confirmation of this TP.

---

**END OF LESSON CONFIRMATION**

---

**QUESTIONS**

- Q1. In what missions did these astronauts take part?
- Q2. What role did these astronauts play on these missions?
- Q3. What education and experience did these astronauts bring to the missions?

**ANTICIPATED ANSWERS**

- A1. As per lesson content.
  - A2. As per lesson content.
  - A3. As per lesson content.
- 

**CONCLUSION**

---

**HOMEWORK/READING/PRACTICE**

N/A.

**METHOD OF EVALUATION**

N/A.

**CLOSING STATEMENT**

Space missions have a short history and a vast future. Cadets can stay current with the space program by frequently visiting websites of the Canadian Space Agency (CSA), the US National Aeronautics and Space Administration (NASA) and other organizations such as the European Space Agency (ESA).

**INSTRUCTOR NOTES/REMARKS**

The instructor shall obtain the latest biographical information for this EO. This material must be updated each year to reflect the Canadian Space Agency's recent activities.

A list shall be kept of astronauts that cadets have focused on to prevent repetition.

---

**REFERENCES**

---

C3-238 Canadian Space Agency. (2008). *Canadian Space Agency*. Retrieved February 9, 2008, from <http://www.space.gc.ca/asc/eng/default.asp>.

THIS PAGE INTENTIONALLY LEFT BLANK



**ROYAL CANADIAN AIR CADETS**  
**PROFICIENCY LEVEL THREE**  
**INSTRUCTIONAL GUIDE**



**SECTION 4**

**EO C340.02 – DISCUSS THE CANADIAN SPACE PROGRAM**

---

Total Time: 30 min

---

**PREPARATION**

---

**PRE-LESSON INSTRUCTIONS**

Resources needed for the delivery of this lesson are listed in the lesson specification located in A-CR-CCP-803/PG-001, Chapter 4. Specific uses for said resources are identified throughout the instructional guide within the TP for which they are required.

Review the lesson content and become familiar with the material prior to delivering the lesson.

Create slides of Annexes M and N.

Photocopy Annex O for each cadet.

**PRE-LESSON ASSIGNMENT**

N/A.

**APPROACH**

An interactive lecture was chosen for this lesson to orient the cadets to the Canadian space program and to generate interest.

---

**INTRODUCTION**

---

**REVIEW**

N/A.

**OBJECTIVES**

By the end of this lesson the cadet shall have discussed the Canadian space program.

**IMPORTANCE**

It is important for cadets to learn about the Canadian space program so they know that Canada participates in space exploration. The Canadian Space Agency (CSA) and its partners are leading the world in research involving space technologies. This information may also generate interest in the many scientific and technical careers involved in the exploration of space.

**Teaching Point 1****Describe Canada's Involvement in Space Technologies**

Time: 10 min

Method: Interactive Lecture



Show slide of Annex M.

**CANADA'S INVOLVEMENT IN SPACE TECHNOLOGIES**

The CSA headquarters is located at the John H. Chapman Space Centre in Saint-Hubert, Que. Canada is involved in many aspects of space exploration. Canadian scientists and researchers are particularly interested with the development and testing of space technologies.



*Canadian Space Agency, 2008, Canadian Space Agency Logo. Retrieved April 14, 2008, from [http://upload.wikimedia.org/wikipedia/en/0/01/Canadian\\_Space\\_Agency\\_logo.png](http://upload.wikimedia.org/wikipedia/en/0/01/Canadian_Space_Agency_logo.png)*

Figure 15-4-1 CSA Logo

**The David Florida Laboratory (DFL)**

The David Florida Laboratory is Canada's world-class spacecraft assembly, integration and testing centre. Named in honour of one of Canada's pioneers in space research, C. David Florida, it is located west of Ottawa, Ont. The laboratory is maintained by the CSA. On a fee-for-service basis, the DFL is available for use by Canadian and foreign aerospace and telecommunication companies and organizations for testing hardware to be used in space. Since its creation in September 1972, DFL has made substantial contributions to satellite communications and remote sensing in Canada and continues to play an essential role in our space program.

**The Canadian Analogue Research Network (CARN)**

CARN is the organization that uses Canadian sites for field studies. These analogue sites approximate conditions that may exist or have existed on Mars and other planetary bodies such as the moon and the Solar System's icy moons.

They provide a unique opportunity to investigate geological and biological processes and hypothesize about planetary bodies. Analogue sites can be used to develop and test specific technology and to understand how to explore and live on other planets. The following are the first three CARN sites selected in 2005:

- Haughton-Mars Project Research Station, Devon Island, Nunavut, 75° 22' N, 89° 41' W;



- McGill Artic Research Station, Axel Heiberg Island, Nunavut, 79° 26' N, 90° 46' W; and
- Pavilion Lake, B.C., 50° 51' N, 121° 44' W.

It is envisioned that CARN will expand in future years with the inclusion of other selected sites.

### **Partnerships With the CSA**

The CSA, formed in 1989, has many partners including international space agencies, industry, post-secondary researchers and educational projects.

One example of the CSA's partnership with international space agencies is the CSA's participation in the International Space Station (ISS). These partners include space agencies from Europe, Japan, Russia and the United States. All of these agencies have sent astronauts to the ISS and they each have ground crews and researchers that support each element of the project.

Industrial partners with the CSA include various Canadian technology companies. MD Robotics is one partner best known for developing and building the first Canadarm. MD Robotics is the prime contractor for the Mobile Servicing System, a sophisticated robotic system critical to assembly, maintenance and servicing of the ISS.

Another technology partner is EMS Technologies, Canada, Ltd. They are a leading provider of wireless, satellite and broadband communication products. EMS Technologies hardware has flown on more than 200 spacecraft.

Many partners of the CSA come from academic institutions. Most of these institutions have a space technology research faculty and their students may be granted money from the CSA to conduct their studies. These schools include the University of British Columbia and the University of Toronto.

The CSA takes great pride in their partnership with educational projects. CSA has a Youth Outreach Group which develops and organizes special educational projects for teachers and youth. CSA believes that students in primary and secondary schools are Canada's next generation of space explorers and researchers. Some of these students are given opportunities to pursue their studies and begin a career in science and technology.



For more information on the CSA and its Youth Outreach Group, access their website at [www.space.gc.ca](http://www.space.gc.ca).

---

## **CONFIRMATION OF TEACHING POINT 1**

---

### **QUESTIONS**

- Q1. Where is DFL located?
- Q2. Analogue sites are used to develop what?
- Q3. List some CSA international partners.

### **ANTICIPATED ANSWERS**

- A1. It is located west of Ottawa, Ont.
- A2. Analogue sites can be used to develop and test specific space technology.
- A3. Space agencies from Europe, Japan, Russia and the United States.

---

**Teaching Point 2****Describe CSA Missions**

Time: 15 min

Method: Interactive Lecture

---

**CSA MISSIONS**

CSA has participated in many space missions with its partners. Canadian astronauts or Canadian technology has gone into space with agencies from the United States, Russia, Europe and Japan. There are four basic types of CSA missions.

**Telecommunications**

Canada is the second largest country on earth and finding ways to communicate over great distances is a challenge. Telecommunication satellites are the most economical way to connect Canadian communities. Being able to keep all places in the country connected with advanced telecommunication services assists every Canadian in competing in the global marketplace. These telecommunication satellites assist search and rescue teams, provide ships and aircraft with geopositioning information, and connect instructors with classrooms across the country.



Ask cadets to list instances where they have probably used telecommunication satellites (eg, long distance cell phone conversations, satellite TV, etc).

Canada's most famous telecommunication satellites are the ANIK series, which were launched in the 1980s, 1990s and as recently as 2004.

**Earth Observation**

Ask cadets to list ideas about what satellites are seeing when they look at the earth.

Canada's earth-observation initiatives enhance our understanding of the planet and its environment. By observing the earth from space, essential information about oceans, ice, land environments and the atmosphere is gathered. Earth-observation satellites collect data that assist scientists monitoring and protecting the environment and managing resources. Some earth-observation satellites gather data that is used by the government to ensure the safety and security of Canadians. Satellite imagery and expertise is also used for global humanitarian efforts. Some examples of earth-observation satellites include:

**Radarsat-1.** Launched in 1995, Radarsat-1 provides the world with an operational radar satellite system capable of the timely delivery of large amounts of data. Radarsat-1 quickly acquires images of the earth day or night, in all weather conditions and through cloud cover, smoke and haze.

**Envisat.** Launched in 2002, Envisat collects specific data for the scientific community in order to better understand climatic processes. Data is collected on ocean-atmosphere heat exchange, interaction between the atmosphere and land or ice surfaces and the composition of the atmosphere and its associated chemical processes. This data helps scientists improve climate models.

**Cloudsat.** Launched in 2006, Cloudsat gathers new data and improve our knowledge of clouds and their effect on climate. Traditional satellites studying the atmosphere can portray the cloud surface accurately, but are

limited to a two-dimensional representation of cloud cover. No data has been available on cloud thickness that would help determine the volume and quantity of water, snow, or ice that clouds contain. Cloudsat was developed by National Aeronautics and Space Administration (NASA) in partnership with the CSA.

**Radarsat-2.** Launched in 2007, Radarsat-2 is Canada's next generation commercial satellite and offers powerful technical advancements. Radarsat-2 has higher resolution cameras and better discrimination of surface types than Radarsat-1. Radarsat-2 will enhance marine surveillance, ice monitoring, disaster management, environmental monitoring, resource management and mapping in Canada and around the world.

### Space Exploration

The CSA is involved with exploring space. Canadian astronauts have been on many missions in various space shuttles and continue to investigate the solar system one small step at a time.



Have the cadets name Canadian astronauts.

Canada is renowned for the exceptional instruments in its science satellites. Some of these satellites collect data that will expand our understanding of the origin, formation, structure and evolution of celestial bodies and the universe.

Another example of the CSA exploring space is the use of Canadian technology in various Martian missions. A Canadian weather station was delivered to an arctic region on Mars in 2008. The instruments measure pressure and temperature, and assess local climate patterns as well as dust, clouds and fog in the lower atmosphere.

Canadians are developing integrated communications networks that will be needed to run a successful international mission on Mars. This will enable Canadians to play a key communications role in future manned exploration to the Red Planet and beyond.

The CSA is supporting a study that focuses on the development of biological air filters for maintaining air quality in a closed system. This research may be used for life support systems and will be crucial for any long duration space exploration missions.

### Space Medicine



Show slide of Annex N.

Space medicine combines many medical specialties to examine the effects of spaceflight on humans and prevent problems associated with living in a unique, isolated, and extreme environment like space. The CSA has a medical department called the Operational Space Medicine (OSM) Group. It is responsible for the health and safety of Canadian astronauts. Studies have shown that the longer an astronaut remains in space, the more changes will take place in the body. While in space many of these changes tend not to be problematic. It is on their return to earth where the effects of living in space are felt. Some examples of effects may be reduced blood volume, diminished reflexes, loss of bone mass and radiation-induced health problems. OSM group is studying many of these changes to try to overcome them in order to send astronauts on longer flights.



Canadian Space Agency, 2008, Operational Space Medicine Logo. Retrieved April 14, 2008, from [http://www.space.gc.ca/asc/eng/astronauts/osm\\_crest.asp](http://www.space.gc.ca/asc/eng/astronauts/osm_crest.asp)

Figure 15-4-2 OSM Logo



Ask cadets if they think that space medicine will help people on earth and how that will happen.

---

## CONFIRMATION OF TEACHING POINT 2

---

### QUESTIONS

- Q1. Why are telecommunication satellites so important to the CSA?
- Q2. How can earth-observation satellites assist scientists monitoring and protecting the environment and managing resources?
- Q3. Name the CSA's medical group.

### ANTICIPATED ANSWERS

- A1. Telecommunication satellites are the most economical way to connect Canadian communities.
- A2. By collecting data.
- A3. OSM Group.

---

**END OF LESSON CONFIRMATION**

---

**QUESTIONS**

- Q1. Where are the three CARN sites in Canada?
- Q2. What are the four basic types of missions that CSA participates in?
- Q3. Where was a Canadian weather station delivered in 2008?

**ANTICIPATED ANSWERS**

- A1. Devon Island, Nunavut, Axel Heiberg Island, Nunavut, and Pavilion Lake, B.C.
- A2. Telecommunications, earth observation, space exploration and space medicine.
- A3. To an arctic region on Mars.



Distribute Annex O to each cadet.

---

**CONCLUSION**

---

**HOMEWORK/READING/PRACTICE**

N/A.

**METHOD OF EVALUATION**

N/A.

**CLOSING STATEMENT**

Even without any domestic launch capabilities of our own, Canadians have made a large impact on space exploration. There are many scientific and technical careers involved in the exploration of space and the CSA and its partners are leading the world in research involving space technologies.

**INSTRUCTOR NOTES/REMARKS**

This material must be updated each year to reflect CSA progress.

---

**REFERENCES**

---

- C3-238 Canadian Space Agency. (2008). *Canadian Space Agency*. Retrieved February 9, 2008, from <http://www.space.gc.ca/asc/eng/default.asp>.

THIS PAGE INTENTIONALLY LEFT BLANK



**ROYAL CANADIAN AIR CADETS**  
**PROFICIENCY LEVEL THREE**  
**INSTRUCTIONAL GUIDE**



**SECTION 5**

**EO C340.03 – DISCUSS UNMANNED SPACE EXPLORATION**

---

Total Time: 60 min

---

**PREPARATION**

---

**PRE-LESSON INSTRUCTIONS**

Resources needed for the delivery of this lesson are listed in the lesson specification located in A-CR-CCP-803/PG-001, Chapter 4. Specific uses for said resources are identified throughout the instructional guide within the TP for which they are required.

Review the lesson content and become familiar with the material prior to delivering the lesson.

Create slides of figures located at Annexes P to S.

Photocopy the handout of page 15Q-4 for each cadet.

Photocopy the *Moons* video worksheet located at page 15S-1.

Cue the video *Moons*.

**PRE-LESSON ASSIGNMENT**

N/A.

**APPROACH**

An interactive lecture was chosen for this lesson to orient the cadets to unmanned space exploration, generate interest, and emphasize the teaching points.

---

**INTRODUCTION**

---

**REVIEW**

N/A.

**OBJECTIVES**

By the end of this lesson the cadet shall have discussed unmanned space exploration.

**IMPORTANCE**

It is important for cadets to learn about unmanned space exploration because it will become increasingly significant as developing technologies and resource depletion move humanity's focus beyond Earth.

**Teaching Point 1****Describe the History of Earth Satellites**

Time: 15 min

Method: Interactive Lecture

**DEVELOPMENT OF LAUNCH CAPABILITY**

To achieve a low earth orbit an object must accelerate to 8 000 m/s. This was first done in 1957 by two liquid-propellant rockets: the Soviet R-7 and America's Jupiter-C.

In 1898, Konstantin Tsiolkovsky (1857–1935), proposed the idea of space exploration by rocket. In 1903, Tsiolkovsky suggested the use of liquid propellants for rockets in order to achieve greater range. For his ideas, careful research and great vision, Tsiolkovsky has been called the father of modern astronautics.



**Astronautics.** The science of space travel.

Early in the 20<sup>th</sup> century, an American, Robert Goddard (1882–1945), conducted practical experiments in rocketry with solid-propellant rockets.



In 1919, Goddard published a pamphlet, *A Method of Reaching Extreme Altitudes*. This was a mathematical analysis of what is today called the meteorological sounding rocket.

Goddard became convinced that a rocket could be better propelled by liquid fuel than by solid fuel. Fuel and oxygen tanks, turbines and combustion chambers would be needed. Goddard achieved the first successful flight with a liquid-propellant rocket on March 16, 1926. The rocket flew for only two and a half seconds, climbed 12.5 m and landed 56 m away in a cabbage patch. Goddard's gasoline rocket was the forerunner of modern rocketry.

Goddard's experiments in liquid-propellant rockets continued for many years. His rockets became bigger, flew higher and carried more cargo. For his achievements, Robert Goddard has been called the father of modern rocketry.



Show the cadets Figures 15P-1 and 15P-2. Point out the major components of the liquid-fuelled rocket in Figure 15P-1 corresponding to the parts listed in Figure 15P-2.

**SOVIET SPUTNIK MISSION**

On October 4, 1957, just 12 years after Goddard's death, the world was stunned by the news of an Earth-orbiting artificial satellite launched by the Soviet Union. Sputnik-1 was the first successful entry in a race for space. Sputnik-1 was a very simple machine. Its mission was to orbit and send repetitive radio signals.



Show the cadets Figures 15P-3 and 15P-4.



The Soviet scientists and engineers launched Sputnik-1 into a low earth orbit by the use of a modified R-7 two-stage rocket. It was the first entirely successful R-7 flight. The R-7 was developed by the military as a means of delivering warhead payloads across vast distances. Such a vehicle was perceived to be necessary for national defence.



Show the cadets Figures 15P-5 and 15P-6.

### UNITED STATES' EXPLORER MISSION

A few months after the launch of Sputnik-1 the United States followed with a satellite of its own, Explorer-1, designed and built by the Jet Propulsion Laboratory (JPL) of the California Institute of Technology. This satellite was launched into orbit by the US Army on January 31, 1958, using a Jupiter-C rocket, which was also developed with warheads in mind. In addition to a radio transmitter, Explorer-1 had a scientific instrumentation package designed and built by Dr. James Van Allen of the State University of Iowa. The instruments were designed to measure the intensity of cosmic radiation in space.



The discovery of the Van Allen Belts by the Explorer satellites was considered to be one of the outstanding discoveries of the International Geophysical Year (1958).

The Jupiter-C launcher was a three-stage rocket. Before the successful launch of Explorer-1, the Jupiter-C was used to loft payloads to various altitudes.



Show the cadets the flight history of Jupiter-C located at Annex P. Point out the work that preceded the successful launch of Explorer-1.



More Jupiter-C history can be found at website <http://history.nasa.gov/sputnik/expinfo.html>

The three-stage Jupiter-C, with Explorer-1 mounted on top, was over 21 m (71 feet) high.



Show the cadets Figures 15P-7 and 15P-8.



Nine months after the launch of Explorer-1, in October 1958, the United States formally organized its space program by creating the National Aeronautics and Space Administration (NASA). NASA became a civilian agency with the goal of peaceful exploration of space for the benefit of all humankind.

---

**CONFIRMATION OF TEACHING POINT 1**

---

**QUESTIONS**

- Q1. Who has been called the father of modern astronautics?
- Q2. Who has been called the father of modern rocketry?
- Q3. When was NASA created?

**ANTICIPATED ANSWERS**

- A1. Konstantin Tsiolkovsky has been called the father of modern astronautics.
- A2. Robert Goddard has been called the father of modern rocketry.
- A3. October 1958.

---

**Teaching Point 2****Describe the Twin Voyager Spacecraft**

Time: 20 min

Method: Interactive Lecture

---

**THE TWIN VOYAGER SPACECRAFT**

The twin spacecraft Voyager-1 and Voyager-2 were launched by NASA in the summer of 1977 from Cape Canaveral, Florida. The Voyagers were to conduct close-up studies of Jupiter, Saturn, Saturn's rings and the larger moons of the two planets. To accomplish their two-planet mission, the spacecraft were built to last five years. As the mission went on, and with the successful achievement of all its objectives, the additional flybys of the two outermost giant planets, Uranus and Neptune, also proved possible.

**The Planetary Voyage**

As the spacecraft flew across the solar system their two-planet mission became four. Their five-year lifetimes stretched to 12 and then to 30 years.

The Voyager mission was designed to take advantage of a rare geometric arrangement of the outer planets in the late 1970s and the 1980s, which allowed for a four-planet tour with minimum propellant and time.

Eventually, Voyager-1 and Voyager-2 would explore all four outer planets of the solar system, 48 of their moons and the unique systems of rings and magnetic fields those planets possess. Had the Voyager mission ended after the Jupiter and Saturn flybys, it still would have provided the material to rewrite astronomy textbooks. Having doubled their itineraries, the Voyagers returned information over the years that has revolutionized the science of planetary astronomy, helping to resolve key questions while raising new ones about the origin and evolution of the planets in our solar system.



Show the cadets Figure 15Q-1.



The layout of Jupiter, Saturn, Uranus and Neptune shown in Figure 15Q-1, which occurs about every 175 years, allows a spacecraft to swing from one planet to the next without the need for large on-board propulsion systems. The flyby of each planet bends the spacecraft's flight path and increases its velocity enough to send it to the next destination. By using this "gravity assist" technique, first demonstrated with NASA's Mariner-10 Venus/Mercury mission in 1973–74, the flight time to Neptune was reduced from 30 years to 12.



Show the cadets Figure 15Q-2.

The original Voyager mission to Jupiter and Saturn sent Voyager-1 to Jupiter on March 5, 1979 and Saturn on November 12, 1980, followed by Voyager-2 to Jupiter on July 9, 1979, and Saturn on August 25, 1981. The two spacecraft's paths differed in that:

- Voyager-1's trajectory was designed to send the spacecraft close to Saturn's large moon, Titan, and behind Saturn's rings.
- Voyager-2 was aimed to fly by Saturn at a point that would automatically send the spacecraft in the direction of Uranus.

After Voyager-2's successful Saturn encounter, it was shown that the spacecraft would likely be able to fly to Uranus with all instruments operating. Subsequently, NASA also authorized the Neptune leg of the mission, which was renamed the Voyager Neptune Interstellar Mission. Voyager-2 encountered Uranus on January 24, 1986, returning detailed photos and other data about the planet, its moons, magnetic field and dark rings.

Voyager-1 continues outward, conducting studies in space beyond the outer planets. Eventually, its instruments may be the first of any spacecraft to sense the heliopause.



The heliopause is the boundary between the end of the Sun's magnetic influence and the beginning of interstellar space.

After Voyager-2's closest approach to Neptune on August 25, 1989, the spacecraft flew a course taking it into interstellar space. Reflecting the Voyagers' new destinations, the project is now known as the Voyager Interstellar Mission.

### **The Voyager Interstellar Mission (VIM)**

The heliopause is the boundary between the solar and the interstellar winds. This is a definitive and unambiguous frontier that the Voyagers will approach and pass through.



Show the cadets Figure 15Q-3.

Voyager-1 crossed the solar wind termination shock in December 2004 and entered into the heliosheath, the turbulent region leading up to the heliopause. The Voyagers should cross the heliopause 10 to 20 years after

reaching the termination shock. In 2007, Voyager-2 was observing preshock phenomena, indicating that it was close to the termination shock.

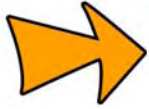

The solar wind termination shock is where the 1 600 000 km/h solar wind slows to about 400 000 km/h on contact with the interstellar winds.

When the Voyagers cross the heliopause, hopefully while the spacecraft are still able to send science data to Earth, they will be in interstellar space. Once Voyager is in interstellar space, it will be immersed in matter that came from explosions of nearby stars.



Show the cadets Figure 15Q-4.

Both spacecraft will continue to study ultraviolet sources among the stars, and the fields and particles instruments aboard the Voyagers will continue to explore the boundary between the sun's influence and interstellar space. The Voyagers are expected to return valuable data for at least another decade. Communications will be maintained until the Voyagers' power sources can no longer supply enough electrical energy to power critical subsystems.

The Voyagers have enough electrical power and thruster fuel to operate until at least 2020. By that time, Voyager-1 will be 19.9 billion km (12.4 billion miles) from the sun and Voyager 2 will be 16.9 billion km (10.5 billion miles) away. The Voyagers are destined – perhaps eternally – to wander the Milky Way.



For current distances of the Voyagers, check mission weekly reports at NASA website <http://voyager.jpl.nasa.gov/mission/weekly-reports/index.htm>.

### The Golden Record



Show the cadets Figure 15Q-5.

NASA placed a message on board Voyager-1 and -2 intended to communicate a story of our world to any extraterrestrials that find the spacecraft. A phonograph record – a 30 cm gold-plated copper disk containing sounds and images selected to portray the diversity of life and culture on Earth, carries the Voyager message. Instructions, in symbolic language, explain the origin of the spacecraft and indicate how the record is to be played. Once the Voyager spacecraft left the solar system (by 1990, both were already beyond the orbit of Pluto), they were in empty space with only the solar wind for company. It will be 40 000 years before they make a close approach to any other planetary system.



Explain symbols of the recording cover diagram as shown in Figure 15-5-1. This is information that extraterrestrials would need to understand the golden record.

**EXPLANATION OF RECORDING COVER DIAGRAM**

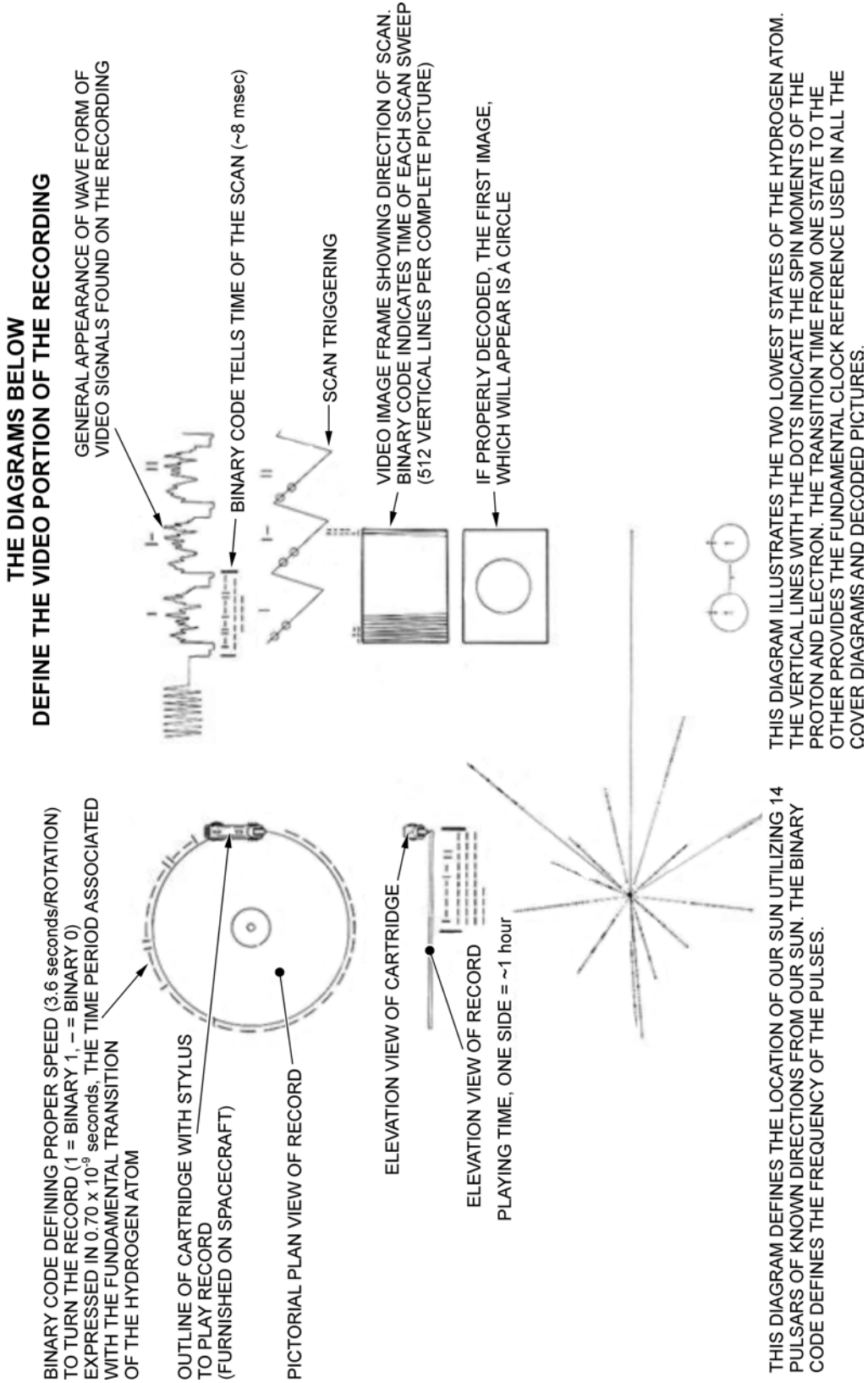

“Voyager: The Interstellar Mission”, by NASA, 2003, *The Golden Record*. Retrieved April 8, 2008, from <http://voyager.jpl.nasa.gov/spacecraft/goldenrec1.html>

Figure 15-5-1 Key to the Golden Record

---

## CONFIRMATION OF TEACHING POINT 2

---

### QUESTIONS

- Q1. In what year were the two Voyager spacecraft launched?
- Q2. Which Voyager spacecraft visited Saturn?
- Q3. For whom was the golden record prepared?

### ANTICIPATED ANSWERS

- A1. 1977.
- A2. Both of them: Voyager-1 in November 1980 and Voyager-2 in August 1981.
- A3. Extraterrestrials.

---

### Teaching Point 3

### Describe Unmanned Space Exploration

Time: 20 min

Method: Interactive Lecture

---

### MISSIONS TO PLANETS WITHIN THE SOLAR SYSTEM

Launched on March 2, 1972, Pioneer-10 was the first spacecraft to travel through the asteroid belt, make direct observations and obtain close-up images of Jupiter. During its Jupiter encounter, Pioneer-10 imaged the planet and its moons and took measurements of Jupiter's magnetic field, atmosphere and interior. These measurements of the environment near Jupiter were crucial in designing later spacecraft.

Pioneer-10 ended its successful mission on March 31, 1997. Pioneer-10's weak signal continued to be tracked by the NASA's Deep Space Network as part of an advanced concept study of communication technology in support of NASA's future interstellar probe mission. The power source on Pioneer-10 finally failed in 2003. Pioneer-10 will continue into interstellar space, heading for the red star Aldebaran, which forms the eye of Taurus (The Bull). It will take Pioneer-10 over 2 million years to reach Aldebaran.

### THE PHOENIX MARS MISSION



Show the cadets Figure 15R-1.

The Phoenix Mars Lander is the first spacecraft designed to visit a polar region of Mars at ground level. Its mission is to explore the soil and atmosphere of the polar regions of Mars to determine if the environment could be hospitable to life.



Show the cadets Figures 15R-2, 15R-3 and 15R-4.

Phoenix was launched from the Kennedy Space Center on August 3, 2007, to land near the northern polar cap of Mars on May 25, 2008, in an area known as Vastitas Borealis. At 125 km (78 miles) above the surface,

Phoenix entered the thin Martian atmosphere. It slowed itself down by using atmospheric friction. A heat shield protected the lander from the extreme temperatures generated during entry.



Show the cadets Figures 15R-5, 15R-6 and 15R-7.

Antennas located on the back of the shell which encases the lander are used to communicate with one of three spacecraft currently orbiting Mars. These orbiters relay signals and landing info to Earth.

### **Mission Characteristics**

In the continuing search for water on Mars, the polar regions are attractive because water ice has been found there. The Phoenix landing site was chosen farther north than previous missions, at a latitude equivalent to that of northern Canada, between 65 and 72 degrees north latitude.

To study Martian atmospheric processes, Phoenix was designed to scan the atmosphere up to 20 km (12.4 miles) in altitude, to obtain data about the formation, duration and movement of clouds, fog, and dust plumes. This capability includes temperature and pressure sensors.



Show the cadets Figure 15R-1. Point out the robotic arm.

Phoenix is equipped with a 2.35 m robotic arm to dig for clues about the history of water on Mars. Although the Phoenix mission will not be capable of moving about on Mars, the Phoenix Lander is designed to investigate by scooping up samples for analysis by its on-board chemistry set. This analysis includes whether the soil is salty, alkaline, and/or oxidizing, and then tests for complex organic molecules necessary for life.



Why would we search for water? Water is a key clue to the most critical scientific questions about Mars. Water is a precursor for life as we know it, a potential resource for human explorers and a major agent of climate and geology.

### **Canada's Lidar Weather Station**

Canada's contribution to the Phoenix mission was a meteorological station that records the daily weather of the Martian northern plains using temperature, wind and pressure sensors, as well as a light detection and ranging (lidar) instrument. The weather station helps improve models of the Martian climate and predict future weather processes, paving the way for future exploration missions. Resembling a brilliant green laser, the lidar probes what is known as the "boundary layer" of the Martian atmosphere (the turbulent layer of the atmosphere about 7–10 km above the surface) and provides information about the structure, composition and optical properties of clouds, fog and dust in the lower atmosphere (up to 20 km above the landing site).

### **THE CASSINI-HUYGENS MISSION TO SATURN**

Four NASA spacecraft have been sent to explore Saturn. Pioneer-11 was first to fly past Saturn in 1979. Voyager-1 flew past a year later, followed by its twin, Voyager-2, in 1981. The fourth spacecraft to visit Saturn was Cassini-Huygens.



---

## ACTIVITY

---

Time: 10 min

---

### OBJECTIVE

The objective of this activity is to have cadets learn an astrophysicist's perspective of the Cassini-Huygens mission.

### RESOURCES

- Five-minute video *Moons* (Reference C3-251),
- Laptop computer,
- Multimedia projector, and
- Projection screen.

### ACTIVITY LAYOUT

N/A.

### ACTIVITY INSTRUCTIONS

1. Distribute the *Moons* video worksheet located at Annex S.
2. Have the cadets read all the questions before the video is started.
3. Have the cadets fill out the worksheet as they watch *Moons*.
4. Correct the answers on the worksheet using the answer key located at Annex T.

### SAFETY

N/A.

---

### Mission Summary

Cassini is the fourth spacecraft to explore Saturn, but the first to explore the Saturnian system of rings and moons from orbit. Cassini carried the Huygens probe to explore the atmosphere of Titan, one of Saturn's more than 60 moons.

Cassini-Huygens' journey to Saturn began on October 15, 1997. The spacecraft was sent to Venus for the first of four planetary gravity assists designed to boost Cassini-Huygens toward Saturn. The spacecraft entered orbit around Saturn on June 30, 2004 and immediately began sending back intriguing images and data.



Show the cadets Figure 15S-1. Point out the Saturnian moons in Figure 15S-1, with particular attention to Titan near the right side of the picture.

Saturn has the most extensive and complex ring system in our solar system. It is made up of billions of particles of ice and rock, ranging in size from grains of sugar to houses. The rings travel at varying speeds. There are

hundreds of individual rings, which are believed pieces of shattered moons, comets and asteroids. Each of the billions of ring particles orbit the planet on their own path.

### Huygens' Descent to Titan

The Huygens probe was released from the Cassini probe and dove into the thick atmosphere of Titan in January 2005. The sophisticated instruments on both spacecraft provided scientists with data and images of this mysterious region of our solar system.



Show the cadets Figures 15S-2 and 15S-3.

It was discovered that Saturn's orange moon, Titan, has hundreds of times more liquid hydrocarbons than all the known oil and natural gas reserves on Earth. The hydrocarbons rain from the sky, collecting in vast deposits that form lakes and dunes. Individual lakes have more oil than the entire Earth.

### Cassini Orbiter Flybys

Cassini-Huygens looped around the Sun twice. On the first orbit it flew close behind Venus in its solar orbit, where it received a gravity assist. The next orbit provided two gravity assists from a second flyby of Venus in June 1999 and of Earth in August 1999. With these three gravity assist boosts, Cassini-Huygens had enough orbital momentum to reach the outer Solar System. One last gravity assist manoeuvre from Jupiter on December 30, 2000 gave Cassini-Huygens the final thrust of energy it needed to reach Saturn. The mission arrived at Saturn in July 2004.

Cassini orbited Saturn for four years, sending back data to Earth. Cassini completed 75 orbits of the ringed planet, 44 close flybys of the mysterious moon Titan, and numerous flybys of Saturn's other icy moons. During a flyby of Saturn's moon Enceladus, it was discovered that there is so much liquid water under Enceladus' frozen surface that it erupts at 400 m per second in geysers that rise into space. Flying at 15 km per second, Cassini passed through the watery plumes at an altitude of 200 km.



Show the cadets Figures 15S-4 and 15S-5.

Whether these and other facts about the Saturnian system turn out to be useful to humans remains to be seen; the European Space Agency states that there is more work left to be done for future scientists.

---

## CONFIRMATION OF TEACHING POINT 3

---

### QUESTIONS

- Q1. What is the mission of the Phoenix lander?
- Q2. Will the Phoenix mission be capable of moving about on Mars?
- Q3. Why would we search for water on Mars, Titan or Enceladus?

**ANTICIPATED ANSWERS**

- A1. To explore the soil and atmosphere of the polar regions of Mars to determine if the environment could be hospitable to life.
- A2. No.
- A3. Water is a precursor for life as we know it, a potential resource for human explorers and a major agent of climate and geology.

**END OF LESSON CONFIRMATION****QUESTIONS**

- Q1. What year was Sputnik-1 launched into space?
- Q2. What outstanding discovery of the International Geophysical Year did Explorer provide?
- Q3. What type of assist did Cassini-Huygens use four times to accelerate?

**ANTICIPATED ANSWERS**

- A1. 1957.
- A2. The Van Allen Belts.
- A3. Gravity assist.

**CONCLUSION****HOMEWORK/READING/PRACTICE**

N/A.

**METHOD OF EVALUATION**

N/A.

**CLOSING STATEMENT**

The half-century from the launch of Sputnik in late 1957 to Huygen's Titan descent in early 2005 saw remarkable accomplishments in space exploration. These were possible due to technological advances and a tenacious refusal to accept defeat despite setbacks.

**INSTRUCTOR NOTES/REMARKS**

TP 2 must be updated each year to reflect current events.

Model kits of spacecraft may be purchased online as training aids.

**REFERENCES**

- C3-238 Canadian Space Agency. (2008). *Canadian Space Agency*. Retrieved February 9, 2008, from <http://www.space.gc.ca/asc/eng/default.asp>.
- C3-239 NASA. (2008). *Voyager: The Interstellar Mission*. Retrieved February 9, 2008, from <http://voyager.jpl.nasa.gov/index.html>.

- C3-240 NASA. (2007). *Sputnik: The Fiftieth Anniversary*. Retrieved February 9, 2008 from <http://history.nasa.gov/sputnik/>.
- C3-241 European Space Agency. (2008). *Cassini-Huygens Homepage*. Retrieved February 9, 2008, from <http://huygens.esa.int/science-e/www/area/index.cfm?fareaid=12>.
- C3-242 NASA. (2008). *NASA Cassini-Huygens Homepage*. Retrieved February 9, 2008, from <http://saturn.jpl.nasa.gov/home/index.cfm>.
- C3-251 European Space Agency. (2008). ESA: Multimedia Gallery Videos. *Moons*. Retrieved April 5, 2008, from <http://www.esa.int/esa-mm/mmg.pl?mission=Cassini-Huygens&type=V>.



**ROYAL CANADIAN AIR CADETS**  
**PROFICIENCY LEVEL THREE**  
**INSTRUCTIONAL GUIDE**



**SECTION 6**

**EO C340.04 – DESCRIBE ELEMENTS OF THE NIGHT SKY**

---

Total Time: 30 min

---

**PREPARATION**

---

**PRE-LESSON INSTRUCTIONS**

Resources needed for the delivery of this lesson are listed in the lesson specification located in A-CR-CCP-803/PG-001, Chapter 4. Specific uses for said resources are identified throughout the instructional guide within the TP for which they are required.

Review the lesson content and become familiar with the material prior to delivering the lesson.

Create slides of Figures 15U-1 to 15U-4.

Visit the National Research Council (NRC) website (Reference C3-221) and retrieve a planisphere star chart, make one copy for each cadet. Prepare one planisphere for use in TP1.

Photocopy Annex V for each cadet.

**PRE-LESSON ASSIGNMENT**

N/A.

**APPROACH**

An interactive lecture was chosen for this lesson to orient the cadets to elements of the night sky, to generate interest and emphasize the teaching points.

---

**INTRODUCTION**

---

**REVIEW**

N/A.

**OBJECTIVES**

By the end of this lesson the cadet shall have described elements of the night sky.

**IMPORTANCE**

It is important for cadets to be able to describe the elements of the night sky so they may apply the knowledge acquired while viewing the night sky or during online stargazing. These activities may generate interest in astronomy.

**Teaching Point 1****Describe Fixed Elements of the Night Sky**

Time: 15 min

Method: Interactive Lecture

**VISIBLE STARS**

Stars are large spherical bodies, many times the size of Earth, composed of hydrogen and heavy elements that are compressed and heated by the pressure of gravitation. This heat and pressure causes nuclear reactions, which make the star visible. A star's gravity then compresses the ongoing nuclear explosion, which prevents the star from disintegrating.

Although the smallest stars are many times larger than Earth, they are so far from Earth that, except for the Sun, they appear as mere luminous points. Their great distance also makes them appear fixed in the sky even though each star is actually moving in a vast orbit around the centre of the galaxy.



Star brightness is called magnitude. The lower the magnitude, the brighter the object. The brightest star visible in the night sky is Sirius, classified as a magnitude of  $-1$ .

Presently, the scale of visibility ranges from a faint magnitude 30, which are objects that can be detected by the Hubble Space Telescope, to a bright magnitude  $-27$  which corresponds with the Sun. On this scale, the Sun is 16 trillion times brighter than a magnitude 6 star.

Ancient peoples imagined patterns using individual stars. One of the most useful and easily identifiable patterns uses seven bright stars: Alkaid, Mizar, Alioth, Megrez, Phekda, Merak and Dubhe. Together these stars form the Big Dipper, which is part of the constellation Ursa Major.



Show the cadets Figure 15U-1.

In the mid-northern hemisphere, the Big Dipper can be seen at any time of the year and at any time of night from everywhere in Canada. The Big Dipper is the most prominent stellar configuration in the night sky. It can easily be identified by untrained observers, making it the ideal reference point for finding other elements of the night sky.

The Big Dipper swings around the sky as the Earth rotates through day and night, so it appears in different orientations. Every 24 hours it circles the North Star (Polaris).



Show the cadets Figure 15U-2.



Show the cadets Figure 15U-3.

## CONSTELLATIONS



Constellations are patterns of stars partitioned and named long ago by our ancestors.

Of the 88 constellations recognized by the International Astronomical Union approximately one quarter of these are in the southern sky and not visible from mid-northern latitudes. About half of the remaining constellations are faint and hard to distinguish.



Hand out Annex U to each cadet.

Many of the visible and well-known constellations are shown in this handout. All constellations, including Ursa Major (the Big Dipper), circle the sky every 24 hours, with Polaris – the North Star – at the centre of the circle.

A planisphere may be used to locate constellations by holding it so the time of year is at the top. This represents the orientation of the constellations as seen at midnight. Remember that the constellations swing around Polaris once every 24 hours and also once every 12 months. A planisphere is only correct at midnight. At midnight, the stars at the top of the planisphere will be in front of an observer facing north and the stars at the bottom of the planisphere will be in front of an observer facing south.



Distribute the two parts of a planisphere retrieved from the NRC website [http://www.nrc-cnrc.gc.ca/docs/education/planisphere\\_e.pdf](http://www.nrc-cnrc.gc.ca/docs/education/planisphere_e.pdf) to each cadet. Demonstrate how to assemble a planisphere using a prepared copy.

---

## ACTIVITY

Time: 5 min

### OBJECTIVE

The objective of this activity is to have the cadets use the Big Dipper to locate other elements of the night sky.

### RESOURCES

Handout of Figure 15U-4 showing the seasonal locations of the constellations in the night sky.

### ACTIVITY LAYOUT

N/A.

### ACTIVITY INSTRUCTIONS

1. Have the cadets rotate their handout so that today's date is located at the top (midnight tonight).
2. Have the cadets find the Big Dipper in Ursa Major.
3. When all cadets have found Ursa Major, have them find Polaris (at centre).

4. When all cadets have found Polaris, have them find the star Sirius in the constellation Canis Major (about July 5 position near the rim).
5. Have the cadets locate their own sign of the Zodiac (hint: midnight on their birthday).

### SAFETY

N/A.

---

### CONFIRMATION OF TEACHING POINT 1

---

The cadets' participation in this activity will serve as the confirmation of this TP.

---

### Teaching Point 2

### Describe Moving Objects of the Night Sky

Time: 10 min

Method: Interactive Lecture

---

### SATELLITES

There are many moving lights in the sky, including aircraft and satellites. A satellite is any celestial body orbiting the earth, but most satellites that are large enough to be seen from the surface of the Earth are man-made. Aircraft have a flashing white light to identify their position as well as red and green wing tip lights, while man-made satellites orbiting the Earth are star-like and do not twinkle. They appear to shine with a steady white glow due to sunlight reflecting off the metal surfaces. Satellites are more prominent during the spring and summer when the Earth's shadow is lower in the sky. Sightings are greater just after dark and drop off close to midnight. Satellites move in a linear fashion at a regular pace, though most observers tend to view their motion as wavy or jerky. Some of these orbiting objects are inhabited by people.



To find the International Space Station (ISS) or any space shuttle, go to NASA's website <http://spaceflight.nasa.gov/realdata/sightings/>. Select your location from the menu and find out where to look in the sky.



Show the cadets Figure 15V-1.

The times that the spacecraft will be visible are listed. The NASA website uses the following format:



**THE FOLLOWING ISS SIGHTINGS ARE POSSIBLE FROM FRI FEB 08 TO WED FEB 20**

<b>SATELLITE</b>	<b>LOCAL DATE/TIME</b>	<b>DURATION (MIN)</b>	<b>MAX ELEV (DEG)</b>	<b>APPROACH (DEG-DIR)</b>	<b>DEPARTURE (DEG-DIR)</b>
ISS	Fri Feb 08/07:04 PM	2	51	20 above WNW	51 above N

*HUMANSPEFLIGHT: Sighting opportunities by NASA, 2003. Retrieved February 8, 2008, from <http://spaceflight.nasa.gov/realdata/sightings/>*

Figure 15-6-1 Building the ISS

The first column lists the spacecraft; the second column gives the date and time of the viewing. The third column shows how long the viewing will be possible. The fourth column shows the maximum height above the horizon that the spacecraft will be seen. The fifth column shows the direction in which the spacecraft will first appear and the final column shows the direction in which it will be last visible.



Hand out Annex V to each cadet.

## PLANETS

The easiest way to observe planets is to know when and where to expect them. This information is readily available on astronomical calendars, observer handbooks and most astronomy resource books or can be easily found on the internet.

<b>Planet</b>	<b>Magnitude</b>	<b>Description</b>
Mercury	0	Mercury is only visible for a few weeks each year because of its orbit. It is yellow and can be seen just after sunset or just before sunrise.
Venus	-4	Venus is visible in the early evening or the early morning for several months each year. It cannot be seen more than four hours after sunset or before sunrise. Venus appears white and is very bright.
Mars	-3 to 1	Because the distance from Earth varies, so does the apparent brightness of Mars. It appears to be a rusty colour due to the light reflecting off the red planet. Mars travels across half the sky in one year, making it interesting to track.
Jupiter	-2 to -3	Jupiter is brighter than most stars but is still not as bright as Venus. Jupiter appears creamy white and can occasionally be seen all night long.

Planet	Magnitude	Description
Saturn	0	Saturn is often mistaken for a star since its brightness matches that of some of the brighter stars. Saturn appears as a pale yellow orb.
Uranus	6	Uranus has a distinct blue-green hue.
Neptune	8	Neptune appears to be approximately the same size of Uranus, though it has a deeper blue hue. They can be differentiated by their position in the sky.

Five planets are visible to the naked eye: Mercury, Venus, Mars, Jupiter and Saturn. Uranus and Neptune must be viewed through binoculars or a telescope.



Planets, like satellites, do not twinkle. Remember, the higher the brightness magnitude, the dimmer the planet – just like stars.

---

### CONFIRMATION OF TEACHING POINT 2

---

#### QUESTIONS

- Q1. What is a satellite?  
 Q2. When is the planet Venus visible?  
 Q3. How many planets are visible to the naked eye?

#### ANTICIPATED ANSWERS

- A1. A satellite is any celestial body orbiting the earth.  
 A2. Venus is visible in the early-evening or the early-morning.  
 A3. Five.

---

### END OF LESSON CONFIRMATION

---

#### QUESTIONS

- Q1. What makes stars visible?  
 Q2. What are constellations?  
 Q3. What is the easiest way to observe planets?

#### ANTICIPATED ANSWERS

- A1. Sustained nuclear reactions caused by the pressure and heat of gravity.  
 A2. Constellations are patterns of stars partitioned and named long ago by our ancestors.  
 A3. The easiest way to observe planets is to know when and where to expect them.

---

**CONCLUSION**

---

**HOMEWORK/READING/PRACTICE**

N/A.

**METHOD OF EVALUATION**

N/A.

**CLOSING STATEMENT**

Knowledge about elements of the night sky is useful when viewing the night sky or during online stargazing. Recognizing these elements will enhance the enjoyment of amateur astronomy.

**INSTRUCTOR NOTES/REMARKS**

This EO may be conducted with EO C390.09 (Identify Elements of the Night Sky, Chapter 18, Section 14).

---

**REFERENCES**

---

- C3-179 (ISBN 1-55209-302-6) Dickenson, T. (2001). *Night Watch: A Practical Guide to Viewing the Universe*. Willowdale, ON: Firefly Books.
- C3-180 (ISBN 1-55297-853-2) Scagell, R. (2004). *Firefly Planisphere: Latitude 42 Deg N*. Willowdale, ON: Firefly Books.
- C3-221 National Research Council of Canada. (2007). *Explore the Night Sky*. Retrieved December 3, 2007, from <http://www.nrc-cnrc.gc.ca/eng/education/astronomy/constellations/html.html>.

THIS PAGE INTENTIONALLY LEFT BLANK



**ROYAL CANADIAN AIR CADETS**  
**PROFICIENCY LEVEL THREE**  
**INSTRUCTIONAL GUIDE**



**SECTION 7**

**EO C340.05 – SIMULATE LIFE IN SPACE**

---

Total Time: 90 min

---

**PREPARATION**

---

**PRE-LESSON INSTRUCTIONS**

Resources needed for the delivery of this lesson are listed in the lesson specification located in A-CR-CCP-803/PG-001, Chapter 4. Specific uses for said resources are identified throughout the instructional guide within the TP for which they are required.

Review the lesson content and become familiar with the material prior to delivering the lesson.

**PRE-LESSON ASSIGNMENT**

N/A.

**APPROACH**

A practical activity was chosen for TP 1 as it is an interactive way to allow cadets to experience some aspects of life in space. This activity contributes to the development of knowledge of life in space in a fun and challenging setting.

An in-class activity was chosen for TPs 2 and 3 as it is an interactive way to provoke thought and simulate some of the challenges of living in space.

---

**INTRODUCTION**

---

**REVIEW**

N/A.

**OBJECTIVES**

By the end of this lesson, the cadet shall have experienced simulated aspects of life in space.

**IMPORTANCE**

It is important for cadets to realize the challenges of living in a space environment in order to understand the Canadian Space Program. A space environment requires many considerations for the human body to exist comfortably including eating, washing, and working.

---

**Teaching Point 1****Explain the Medical Effects of Weightlessness**

Time: 35 min

Method: Practical Activity

---

**MEDICAL EFFECTS OF WEIGHTLESSNESS**

On Earth, gravity pulls everything down. Thus, the lower torso and legs carry the weight of the body. In space, because of zero gravity, astronauts float and the legs are not used to support the body.

In space, the lower back and leg muscles are affected the same way as muscles that have been in a cast for a while. Muscles become flabby and lose tone and mass and the astronaut experiences “bird leg syndrome”. “Bird leg syndrome”, called muscular atrophy, makes the limbs thinner. The bones also become weaker because of the loss of minerals like calcium, potassium, and sodium.

The weightlessness of space also affects the cardiovascular system. On Earth, because of gravity, blood naturally pools in the legs, forcing the heart to pump against gravity to supply enough blood to the brain. In space, the heart acts the same as it would on Earth. However, because there is no gravity, the blood rushes to the torso and head. In space the astronaut experiences “puffy face syndrome”. The veins in the neck and face stand out more, and the eyes become red and swollen.

Astronauts try to lessen “puffy face” and “bird leg” syndromes by exercising as often as possible. Astronauts must exercise at least two hours every day to keep their muscles healthy. Astronauts use exercise machines to work both the lower and the upper body muscles. They use a series of straps and restraints to remain secure against the exercise equipment.

---

**ACTIVITY**Time: 25 min

---

**OBJECTIVE**

The objective of this activity is to have the cadets simulate exercises that astronauts must perform to maintain bone density and muscle mass when living in a space environment.

**RESOURCES**

N/A.

**ACTIVITY LAYOUT**

N/A.

**ACTIVITY INSTRUCTIONS**

1. Have the cadets stretch for two minutes.
2. Have the cadets alternate between running on the spot and jumping jacks for eight minutes.
3. Have the cadets stretch for two minutes.
4. Have the cadets brainstorm and design exercises that will allow astronauts to keep a set of muscle groups fit in a weightless environment.

**SAFETY**

N/A.

---

## CONFIRMATION OF TEACHING POINT 1

---

### QUESTIONS

- Q1. What do astronauts use to exercise?
- Q2. What happens to an astronaut in zero gravity?
- Q3. How is the cardiovascular system affected in space?

### ANTICIPATED ANSWERS

- A1. Astronauts use exercise machines to work both the lower and the upper body muscles.
- A2. Astronauts float and their legs are not used to support the body.
- A3. Due to the lack of gravity the blood rushes to the torso and head.

---

### Teaching Point 2

### Explain the Challenges of Living in Space

Time: 30 min

Method: In-Class Activity

---

### CHALLENGES OF LIVING IN SPACE

#### Washing Hands With Rinseless Soap

In space, astronauts cannot wash with water, as water is very difficult to contain in a zero gravity environment. If water drops were left floating in the space vehicle, they could cause serious problems with the equipment. Astronauts use rinseless soap during space missions to clean themselves. Rinseless soap applies easily, the same way as regular soap or hair shampoo, and does not require water to be effective. The alcohol in the rinseless soap kills bacteria.

#### Sampling Space Food

There are many factors to consider when astronauts live in a space environment and one of these is food. The preparation of the food itself requires special considerations. Storage and transport require the product to be lightweight and have a long shelf life without refrigeration. Weight is critical during a space mission due to transport cost and efficiency. Some methods of food preparation and storage include freeze-drying, retort packing at 125 degrees Celsius, vacuum packing, and dehydrating. Preservation of taste and texture can be difficult with some of these methods. An example of space food is freeze-dried ice cream or strawberries.



Have the cadets feel how light the package of space freeze-dried ice cream or strawberries are by allowing them to hold the wrapped product.

Some dehydrated foods require rehydration, such as macaroni and cheese or spaghetti. The water is kept contained during the transfer from reservoir to food package to avoid loss. An oven is provided in the space shuttle and the space station to heat foods to the proper temperature.

Condiments such as ketchup, mustard, and mayonnaise are provided. Salt and pepper are available, but only in a liquid form, because astronauts cannot sprinkle salt and pepper on their food. The salt and pepper would simply float away. The particles could clog air vents, contaminate equipment or enter an astronaut's eyes, mouth, or nose.

Astronauts eat three meals a day – breakfast, lunch and dinner. Nutritionists ensure the food astronauts eat provides a balanced supply of vitamins and minerals. Caloric requirements differ for different astronauts. For instance, a small astronaut weighing approximately 54 kg would require only about 1900 calories a day, while a large astronaut weighing 100 kg would require about 3200 calories a day.

There are many foods an astronaut can choose from, such as:

- fruits,
- nuts,
- peanut butter,
- chicken,
- beef,
- seafood,
- candy, and
- brownies.

Possible drinks include:

- coffee,
- tea,
- orange juice,
- fruit punches, and
- lemonade.

As on earth, space food comes in packages that must be disposed of. Astronauts must dispose of the packages in a trash compactor inside the space shuttle when they are finished eating. Some packaging actually prevents food from floating away. Food packages are designed to be flexible, easy to use and to maximize space when being stowed or disposed of.

---

## ACTIVITY

Time: 20 min

---

### OBJECTIVE

The objective of this activity is to have the cadets simulate how astronauts wash and eat in space.

### RESOURCES

- Freeze-dried strawberries,
- Other freeze-dried fruit as available,
- Freeze-dried ice cream, and
- Rinseless soap.



**ACTIVITY LAYOUT**

N/A.

**ACTIVITY INSTRUCTIONS**

1. Divide the cadets into groups of three.
2. Distribute rinseless soap to each group of cadets.
3. Have the cadets wash their hands.
4. Distribute a package of freeze-dried ice cream and strawberries to each group of cadets.
5. Have the cadets taste the freeze-dried ice cream and strawberries.

**SAFETY**

- Warn cadets and staff that are lactose intolerant that the ice cream contains milk products.
- Warn cadets and staff with an allergy to strawberries that the freeze-dried strawberries are real strawberries.

**CONFIRMATION OF TEACHING POINT 2****QUESTIONS**

- Q1. Why are dehydrated foods used by astronauts for some of their meals?
- Q2. What do astronauts use to wash their hands and hair?
- Q3. Why would salt and pepper be a problem in a space environment?

**ANTICIPATED ANSWERS**

- A1. Dehydrating food is used to reduce weight and increase shelf life.
- A2. They use rinseless soap and shampoo.
- A3. The grains of salt or pepper could clog air vents, contaminate equipment or enter an astronaut's eyes, mouth, or nose.

**Teaching Point 3****Have the Cadets Simulate Working in Space by Installing a Nut on a Bolt Wearing Two Pairs of Thick Work Gloves**

Time: 20 min

Method: In-Class Activity

Working in zero gravity is a challenge. Often, the only resistance felt by astronauts is the spacesuit itself. In weightless space, any movement in any direction encounters Newton's Third Law and causes an equal force in the opposite direction. For example, when turning a bolt, the force applied in any direction results in an equal force in the opposite direction. Astronauts must attach themselves to, or hold on to, any object to work on it so that they can control the opposite reactive effect.



Newton's Third Law: for every action there is an equal and opposite reaction.

Spacesuits introduce constraints on movement because they are bulky and, being pressurized, they are stiff. The pressure in an astronaut's spacesuit is 4.3 pounds per square inch (psi). That is less than one-third of the pressure of Earth's atmosphere at sea level (14.7 psi). The air pressure outside an airplane flying at 35 000 feet is near 4.3 psi. It is also about the same as the extra pressure that keeps a football inflated, and like a football, the suit is hard to bend.

Pressure is especially noticeable when wearing gloves. Spacesuit gloves are designed so that there is little pressure when the hand is at rest, but resistance can be felt when the hand is open. This makes manipulating objects difficult when working in the spacesuit.

Tools used in a space environment must be two to three times larger than normal because the gloves are bulky and make manipulating the regular-sized tools difficult. In space, it becomes difficult to do tasks that would be easy to do on Earth. Small details like threading nuts onto bolts require more effort and, worse, dropped objects can be hazardous as they continuously float around and may damage other instruments, controls, or surfaces.

---

### ACTIVITY

Time: 15 min

---

#### OBJECTIVE

The objective of this activity is to have the cadets simulate what astronauts do to manipulate objects in a space environment.

#### RESOURCES

- Work gloves, and
- 1/2-inch National Coarse nuts and bolts.

#### ACTIVITY LAYOUT

N/A.

#### ACTIVITY INSTRUCTIONS

1. Divide the cadets into groups of six.
2. Give each group of cadets two pair of gloves and a bolt and a nut.
3. Have one cadet from each group put on two pairs of work gloves and try to pick up the bolt.
4. Put the nut in the cadets' gloved hand and ask the cadet to put the nut on the bolt.
5. Have each cadet perform Steps 3. and 4.

#### SAFETY

N/A.

---

### CONFIRMATION OF TEACHING POINT 3

---

#### QUESTIONS

- Q1. What are some of the constraints of the spacesuit?
- Q2. What law of motion applies to moving in space?

Q3. Why are tools used in space two to three times larger than tools used on Earth?

**ANTICIPATED ANSWERS**

- A1. A spacesuit is stiff because it is pressurized and it is bulky.
- A2. Newton's Third Law of motion: for every action there is an equal and opposite reaction.
- A3. Spacesuit gloves are stiff and bulky, which restricts the ability to manipulate smaller objects.

---

**END OF LESSON CONFIRMATION**

---

The cadets' participation in all the activities will serve as the confirmation of this lesson.

---

**CONCLUSION**

---

**HOMEWORK/READING/PRACTICE**

N/A.

**METHOD OF EVALUATION**

N/A.

**CLOSING STATEMENT**

Astronauts living in a space environment face many challenges, even in simple things such as washing and eating. With careful planning and consideration of these challenges, life in space can be comfortable and fun.

**INSTRUCTOR NOTES/REMARKS**

N/A.

---

**REFERENCES**

---

C3-183 (ISBN 978-0-75662-227-5) Graham, I. (2006). *DK Online, Space Travel*. New York, NY: DK Publishing, Inc.

THIS PAGE INTENTIONALLY LEFT BLANK



**ROYAL CANADIAN AIR CADETS**  
**PROFICIENCY LEVEL THREE**  
**INSTRUCTIONAL GUIDE**



**SECTION 8**

**EO C340.06 – LAUNCH A WATER ROCKET**

---

Total Time:	90 min
-------------	--------

---

**PREPARATION**

---

**PRE-LESSON INSTRUCTIONS**

Resources needed for the delivery of this lesson are listed in the lesson specification located in A-CR-CCP-803/PG-001, Chapter 4. Specific uses for said resources are identified throughout the instructional guide within the TP for which they are required.

Review the lesson content and become familiar with the material prior to delivering the lesson.

Construct a launching pad as shown at Annex W.

Prepare a string guidance system as shown at Annex X.

Photocopy Annex Y for each cadet.

**PRE-LESSON ASSIGNMENT**

N/A.

**APPROACH**

A practical activity was chosen for TPs 1 and 2 as it is an interactive way to introduce cadets to water rockets. This activity contributes to the understanding of rocketry in a fun and challenging setting.

A group discussion was chosen for TP 3 as it allows the cadets to interact with their peers and share their knowledge, experiences, opinions, and feelings about water rockets.

---

**INTRODUCTION**

---

**REVIEW**

N/A.

**OBJECTIVES**

By the end of this lesson the cadet, as a member of a group, shall have constructed and launched a water rocket.

**IMPORTANCE**

It is important for cadets to launch a water rocket so that they can experience the difference that a higher exhaust pressure makes in rocket flight, compared with using an effervescent tablet for power as was done in EO M140.01 (Build and Launch a Model Rocket, A-CR-CCP-801/PF-001, Chapter 13, Section 1).

**Teaching Point 1****Supervise the Cadets constructing a Water Rocket**

Time: 20 min

Method: Practical Activity



Supervise the cadets as they construct a water rocket, to include:

1. fuselage,
2. stabilizing fins,
3. nose cone,
4. centre of gravity trimming, and
5. decorations.

**ACTIVITY****OBJECTIVE**

The object of this activity is to have the cadets construct a water rocket, which will fly under its own self-contained power.

**RESOURCES**

- One-litre plastic pop bottles with caps removed,
- Construction paper,
- Scissors,
- Glue,
- Putty or modelling clay,
- Packing tape, and
- Instructions for constructing a water rocket.

**ACTIVITY LAYOUT**

Cadets shall be organized in groups of no more than four, working together at one table, with all the resources required to build a water rocket.

**ACTIVITY INSTRUCTIONS**

1. Give each cadet a copy of Annex Y.
2. Explain the instructions located at Annex Y.
3. Each group will construct a water rocket in the manner depicted in Figure 15Y-1.

**SAFETY**

N/A.

---

## CONFIRMATION OF TEACHING POINT 1

---

The cadets' participation in the activity will serve as the confirmation of this TP.

---

### Teaching Point 2

### Supervise the Cadets Launching a Water Rocket

Time: 50 min

Method: Practical Activity

---

## ACTIVITY

---

### OBJECTIVE

The objective of this activity is to have each group of cadets launch a water rocket constructed in TP 1 and experimentally determine its flight characteristics.

### RESOURCES

- Water rockets constructed in TP 1,
- Air pump with pressure gauge,
- Launch pad,
- Drinking straws,
- Packing tape,
- 3-mm string, and
- Safety glasses.

### ACTIVITY LAYOUT

1. The CO shall select an outdoor area with controlled access for this training, at least 10 m by 20 m.
2. The string guidance system shall be secured to a suitable tower and the launch pad.
3. Place the launch pad in the centre of the launch area.
4. Anchor the launch pad securely in place.

### ACTIVITY INSTRUCTIONS

1. Have one group of cadets place their water rocket, quarter filled with water, on the launch pad.
2. Ensure other cadets stand back 5 m; if necessary, rope off the launch site.
3. After the water rocket is attached to the launcher, have one cadet pump air into the rocket to more than 344 kPa (50 psi) pressure.
4. When pressurization is complete, all cadets shall stand behind the launch control officer.
5. Before conducting the countdown, ensure that the guidance system area is clear.
6. Have one cadet launch the water rocket by pulling the launch release cord.
7. Repeat this process for each group.

8. When all water rockets have been launched, have the cadets retrieve their water rockets.

**SAFETY**

- Safety glasses must be worn by all cadets and staff during this activity.
- In case of a misfire, the instructor shall ensure that no one approaches the launch pad until the instructor has removed the misfired water rocket.

---

**CONFIRMATION OF TEACHING POINT 2**

---

The cadets' participation in launching a water rocket will serve as the confirmation of this TP.

---

**Teaching Point 3**

**Conduct an Activity Debriefing**

Time: 10 min

Method: Group Discussion

---

**BACKGROUND KNOWLEDGE**

---



The point of the group discussion is to draw the following information from the group using the tips for answering/facilitating discussion and the suggested questions provided.

**Characteristics of the Successful Launches**

The forces acting upon the cadets' water rockets in flight are those acting upon any aircraft:

- gravity,
- thrust,
- drag, and
- lift, which is minimal in this case unless the water rocket is provided with an airfoil.

Drag and lift are atmospheric forces that result from air coming in contact with the body of the water rocket.

There are many propellants used in rocketry, resulting in a variety of exhaust pressures and velocities. The greater the exhaust pressure, the higher the exhaust velocity. The rocket's power is increased as exhaust velocity of the propellant increases.

When launching a water rocket, there is a difference that a higher exhaust pressure makes in rocket flight, compared with using an effervescent tablet for power as was done in EO M140.01 (Build and Launch a Model Rocket, A-CR-CCP-801/PF-001, Chapter 13, Section 1). Since the water rocket launched in this lesson is heavier when filled with propellant, it may start slower, but the greater mass of the propellant may allow it to attain even greater speeds and distances.

**Rocket Behaviour Under Newton's Laws**

**First Law.** Every object in motion tends to remain in motion until an external force is applied to it.



**Second Law.** The direction of acceleration is the same as the direction of the force. Therefore, since the reactive force pushes upwards against the bottle as the water is directed downwards, the force acting upon the water rocket is also directed upwards.

**Third Law.** For every action there is an equal and opposite reaction. Therefore, matter such as water particles escaping outward from the rear nozzle will push upon the body of the water rocket.

---

## GROUP DISCUSSION

---



### TIPS FOR ANSWERING/FACILITATING DISCUSSION

- Establish ground rules for discussion, eg, everyone should listen respectfully; don't interrupt; only one person speaks at a time; no one's ideas should be made fun of; you can disagree with ideas but not with the person; try to understand others as much as you hope they understand you; etc.
- Sit the group in a circle, making sure all cadets can be seen by everyone else.
- Ask questions that will provoke thought; in other words avoid questions with yes or no answers.
- Manage time by ensuring the cadets stay on topic.
- Listen and respond in a way that indicates you have heard and understood the cadet. This can be done by paraphrasing their ideas.
- Give the cadets time to respond to your questions.
- Ensure every cadet has an opportunity to participate. One option is to go around the group and have each cadet answer the question with a short answer. Cadets must also have the option to pass if they wish.
- Additional questions should be prepared ahead of time.

### SUGGESTED QUESTIONS

- Q1. Which rocket was heavier? The water rocket or the film canister rocket in Proficiency Level One?
- Q2. Which rocket flew further?
- Q3. Which rocket flew faster?
- Q4. How might increased pressure or an increased volume of propellant affect the rocket?



Other questions and answers will develop throughout the group discussion. The group discussion should not be limited to only those suggested.



Reinforce those answers given and comments made during the group discussion, ensuring the teaching point has been covered.

---

**CONFIRMATION OF TEACHING POINT 3**

---

The cadets' participation in the group discussion will serve as the confirmation of this TP.

---

**END OF LESSON CONFIRMATION**

---

The cadets' participation in launching the water rocket and in the group discussion will serve as the confirmation of this lesson.

---

**CONCLUSION**

---

**HOMEWORK/READING/PRACTICE**

N/A.

**METHOD OF EVALUATION**

N/A.

**CLOSING STATEMENT**

There are many propellants used in rocketry, resulting in a variety of exhaust pressures and velocities. The greater the exhaust pressure, the higher the exhaust velocity. The rocket's power is increased as exhaust velocity of the propellant increases.

**INSTRUCTOR NOTES/REMARKS**

Prior to this lesson, instructors shall prepare a launching platform and guidance system as shown at Annexes W and X or reference C3-016.

The launching pad should be saved for future training.

Each group shall be allowed a number of attempts to achieve a successful launch.

If a suitable location for this launching water rockets is not available at the squadron's LHQ, that part of the lesson can be carried out as part of a field exercise.

---

**REFERENCES**

---

C3-016 EG-2003-01-108-HQ NASA. (2003). *Rockets: A Teacher's Guide With Activities in Science, Mathematics, and Technology*. Washington, DC: NASA.



**ROYAL CANADIAN AIR CADETS**  
**PROFICIENCY LEVEL THREE**  
**INSTRUCTIONAL GUIDE**



**SECTION 9**

**EO C340.07 – IDENTIFY GLOBAL POSITION SYSTEM (GPS) COMPONENTS**

---

Total Time: 60 min

---

**PREPARATION**

---

**PRE-LESSON INSTRUCTIONS**

Resources needed for the delivery of this lesson are listed in the lesson specification located in A-CR-CCP-803/PG-001, Chapter 4. Specific uses for said resources are identified throughout the instructional guide within the TP for which they are required.

Review the lesson content and become familiar with the material prior to delivering the lesson.

Retrieve current information from reference C3-243 and update the lesson as required.

Create slides of figures located at Annexes Z to AB.

**PRE-LESSON ASSIGNMENT**

N/A.

**APPROACH**

An interactive lecture was chosen for this lesson to orient the cadets to GPS components, to generate interest, and emphasize the teaching points.

---

**INTRODUCTION**

---

**REVIEW**

N/A.

**OBJECTIVES**

By the end of this lesson the cadet shall be have identified GPS components.

**IMPORTANCE**

It is important for cadets to be able to identify GPS components so that they will clearly understand the operation and capabilities of GPS when it is used in the field or in an aircraft.

---

**Teaching Point 1****Explain How the GPS Operates**

Time: 25 min

Method: Interactive Lecture

---

In 1870, an American named Edward Everett Hale suggested a system of four satellites be placed in a circumpolar orbit to provide a global positioning service. This idea was published as a story called *The Brick Moon* in a series of installments in Boston's Atlantic Monthly magazine in 1870 and 1871.



The complete *The Brick Moon* is available at the University of Virginia Library at website <http://etext.virginia.edu/toc/modeng/public/HalBric.html>.

**THE THREE COMPONENTS OF GPS**

There are multiple positioning systems that use satellites, including the Russian military's Glonass system and the US military's Navstar system. This lesson describes Navstar, but both systems share the same principles in data transmission and positioning methods, though other details such as orbits differ. Other systems existing or planned include those belonging to Japan and the European Union.

Today's GPS represents a considerable advance from Hale's brick moon idea. It has three components:

- orbiting satellites,
- earthbound control stations, and
- receivers that can be anywhere – earthbound, flying or orbiting.

**Satellites**

The space segment of GPS consists of 24 operational satellites in six orbital planes (four satellites in each plane). The spacing of the satellites are arranged so that a minimum of five satellites are in view from every point on the globe at any time. The satellites orbit at an altitude of 20 200 km. That altitude, clear of the atmosphere, means that satellites will orbit according to very simple mathematics. Although all the satellites are at the same altitude and their six orbits do cross, the satellites do not collide because they are carefully synchronized.

**Control Stations**

The control segment of GPS consists of five monitor stations and three ground antennas located around the world. A Master Control Station (MCS) is located at Schriever Air Force Base (AFB) in Colorado. The monitor stations passively track all satellites, gathering information to be processed at the MCS to determine satellite orbits and to update each satellite's navigation message. Updated information is transmitted to each satellite via the ground antennas.

**Receivers**

The user segment of GPS consists of antennas and receiver-processors that provide positioning, velocity, and precise timing to the user. There is a wide variety of receivers.

Individuals may purchase GPS handsets that are available through commercial retailers. Equipped with these GPS receivers, users can accurately locate where they are and easily navigate to where they want to go, whether walking, driving, flying, or boating. GPS receivers have become a mainstay of transportation systems worldwide, providing navigation for aviation, ground, and maritime operations. Disaster relief and emergency services depend upon GPS receivers for location and timing capabilities in their life-saving missions. Everyday activities such as banking, mobile phone operations, and even the control of power grids, are facilitated by the

accurate timing provided by GPS receivers. Farmers, surveyors, geologists and countless others perform their work more efficiently, safely, economically, and accurately using the free and open signals of the GPS satellites.

### TRILATERATION FROM THREE SATELLITES



Since angles are not used in the computation, trilateration is a more accurate term than the popular term triangulation. However, the term triangulation is used by most people. For the purposes of this lesson, the two terms are interchangeable.

The principle behind GPS is the use of satellites in space as reference points for describing locations on earth. By very accurately measuring distance from three satellites a position can be trilaterated anywhere on or over the earth.



Show the cadets Figure 15Z-1.

A single measurement of distance from a satellite might find the distance to be 22 000 km. Knowing that this location is 22 000 km from a particular satellite narrows down all the possible locations one could be, to the surface of a sphere that is centered on this satellite and has a radius of 22 000 km.

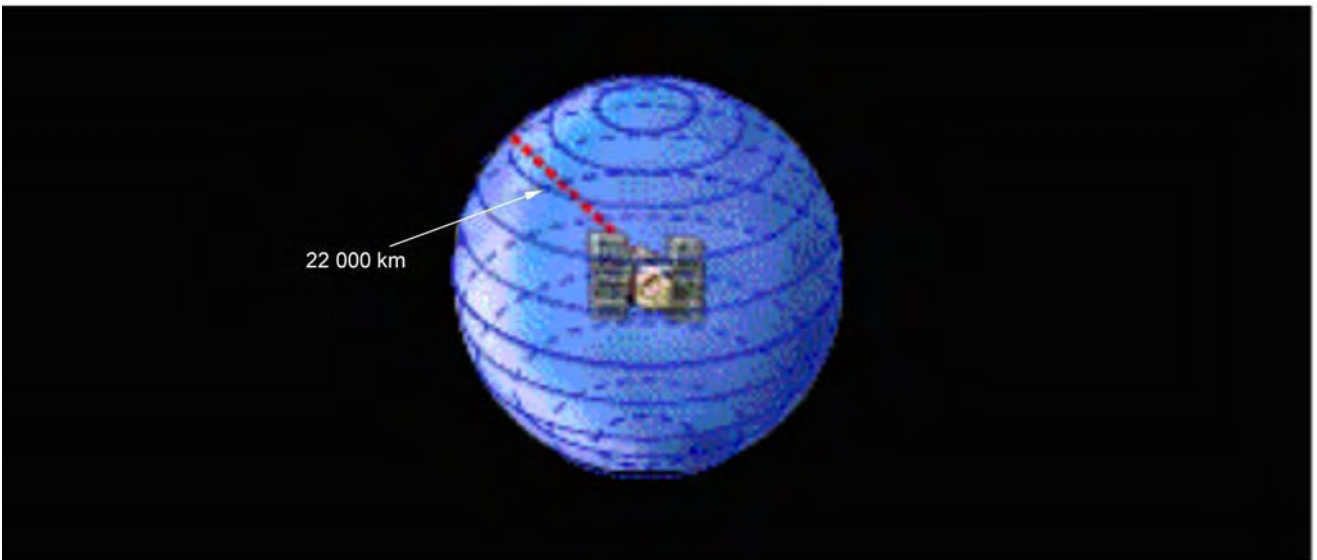

*“GPS Tutorial”, Trimble Navigation Limited, 2008, How GPS Works? Copyright 2008 by Trimble Navigation Limited. Retrieved April 11, 2008, from <http://www.trimble.com/gps/howgps-triangulating.shtml>*

Figure 15-9-1 First Trilateration

If a second measurement shows this same location to be 23 000 km from a second satellite, it is not only on the first sphere but also on a sphere 23 000 km from the second satellite. The location must be somewhere on the circle where these two spheres intersect.

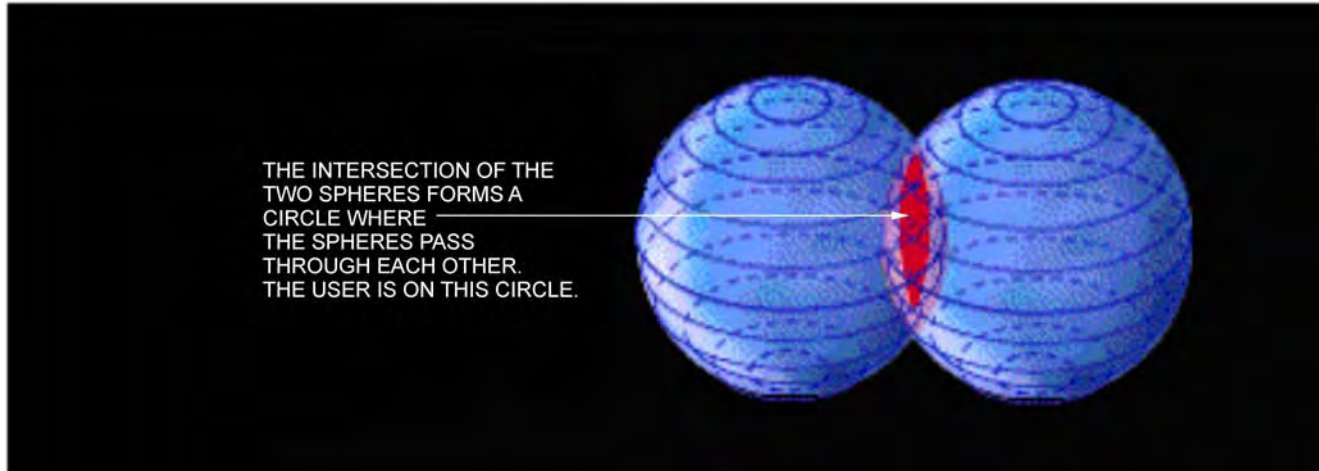

*“GPS Tutorial”, Trimble Navigation Limited, 2008, How GPS Works? Copyright 2008 by Trimble Navigation Limited. Retrieved April 11, 2008, from <http://www.trimble.com/gps/howgps-triangulating.shtml>*

Figure 15-9-2 Second Trilateration

If a third measurement shows the same location to be 24 000 km from a third satellite, it is not only on the first sphere and the second sphere, but also on another sphere that is 24 000 km from the third satellite. This narrows the location down to the two points where the 24 000 km sphere intersects with the circle formed by the intersection of the first two spheres.

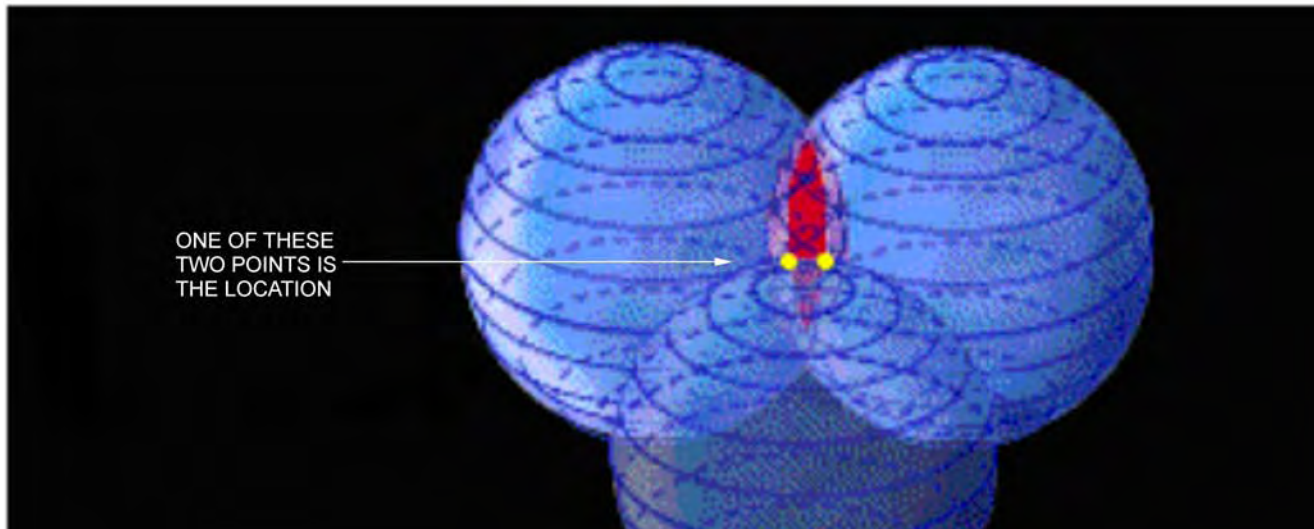

*“GPS Tutorial”, Trimble Navigation Limited, 2008, How GPS Works? Copyright 2008 by Trimble Navigation Limited. Retrieved April 11, 2008, from <http://www.trimble.com/gps/howgps-triangulating.shtml>*

Figure 15-9-3 Third Trilateration

From three satellites a location can be determined to be one of just two points in space – only one of which will usually be on the surface of the earth or at the correct altitude above it. To decide which of those two points is the true location, a fourth trilateration measurement is necessary. However, one of the two points may be a ridiculous answer (either too far from Earth or moving at an impossible velocity) and so can be rejected without further measurement.

## TIMING RADIO SIGNALS



Show the cadets Figures 15AA-1 and 15AA-2.

Distance to a satellite is determined by measuring how long a radio signal takes to travel from that satellite to the user's receiver. By comparing how long it takes the satellite's coded signal to arrive at the user's receiver, compared to the receiver's internal clock, the travel time can be determined. Finally, comparing that measured travel time to the speed of light gives the distance.



*"GPS Tutorial", Trimble Navigation Limited, 2008, How GPS Works? Copyright 2008 by Trimble Navigation Limited. Retrieved April 11, 2008, from <http://www.trimble.com/gps/howgps-triangulating.shtml>*

Figure 15-9-4 Travelling Down

Each GPS satellite transmits a coded waveform radio signal (somewhat like those shown in Figure 15-9-5). Notice that the individual pulses, or waves, are of different shapes. This allows the receiver to recognize individual pulses. GPS receivers generate waveforms that are identical to those transmitted by the satellite, for the receiver's internal use. To calculate the travel time of the radio signal from the GPS satellite, the GPS receiver measures how much time the received satellite waveform is behind its own identical internal waveform. It does this by comparing synchronization of its own internal waveforms with that of the waveforms received from each satellite.

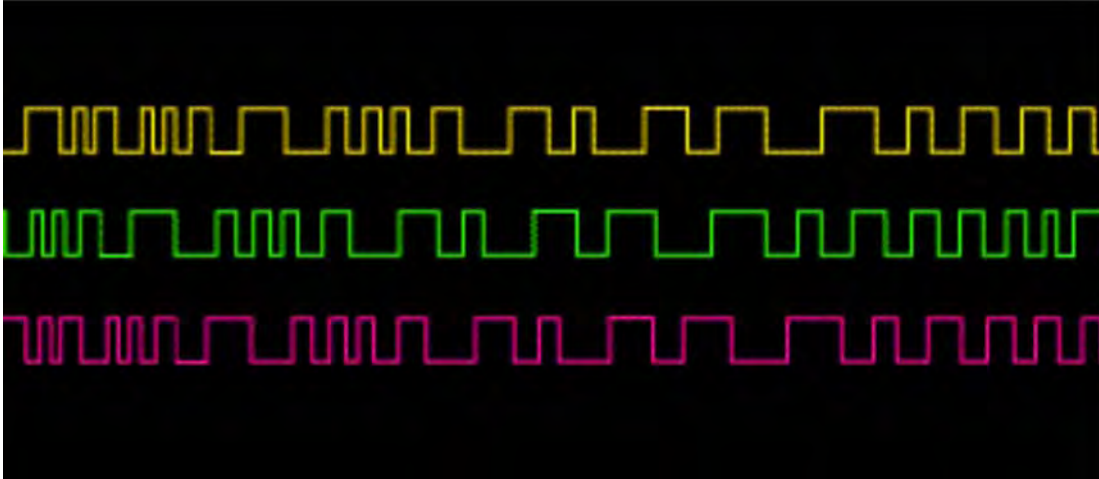

*“GPS Tutorial”, Trimble Navigation Limited, 2008, How GPS Works? Copyright 2008 by Trimble Navigation Limited. Retrieved April 11, 2008, from <http://www.trimble.com/gps/howgps-triangulating.shtml>*

Figure 15-9-5 Coded Signals

Of course, this system requires perfect synchronization. All three of the GPS components – satellites, control stations and receivers – have excellent timekeeping ability.



Show the cadets The Challenge of Timing slide located at Annex AA.



Timing is tricky.  
Precise clocks are needed to measure travel time.  
The travel time from a satellite directly overhead is about 0.06 seconds.  
The time required to synchronize the receiver’s internal coded pulses with the satellite’s coded pulses is equal to the travel time.  
Distance to the satellite is equal to travel time multiplied by the speed of light.

As well as extremely accurate internal timing, the GPS receiver must have one last critical piece of information – the exact time on the satellite’s clock. The speed of light is so great, and the travel time of the radio signal is so short, that the clock in the GPS satellite and the clock in the GPS receiver must be synchronized perfectly. This requirement, given the degree of accuracy necessary, is a formidable challenge. The method that was used to accomplish this feat involves high-speed computer processing combined with data from a fourth GPS satellite.

---

### ACTIVITY

Time: 10 min

---

### OBJECTIVE

The objective of this activity is to have the cadets experience the precision of GPS.



**RESOURCES**

- One hand-held GPS receiver, and
- Paper and pencil/pen.

**ACTIVITY LAYOUT**

Training area suitable for drill.

**ACTIVITY INSTRUCTIONS**

1. Designate a right marker.
2. Face the right marker south.
3. Have the remaining cadets fall in single file and perform a right dress.
4. Give the marker a hand-held GPS receiver.
5. Have the marker call out the coordinates shown on the GPS receiver and pass the receiver to the next cadet.
6. Write down the marker's coordinates.
7. Repeat Steps 5. and 6. for each cadet in the file.
8. List the coordinates on a whiteboard or flip chart.
9. Have the cadets examine the listed coordinates to determine:
  - a. How many seconds did the longitude change from one end of the file to the other?
  - b. How many seconds did the longitude change per cadet, on average?

**SAFETY**

N/A.

---

**CONFIRMATION OF TEACHING POINT 1**

---

**QUESTIONS**

- Q1. What are the three components of the GPS?
- Q2. How many satellites does it take to mathematically establish a location?
- Q3. How is distance to a single satellite determined?

**ANTICIPATED ANSWERS**

- A1. Satellites, control stations and receivers.
- A2. Four.
- A3. By measuring how long a radio signal takes to travel from that satellite to the user's receiver.

---

**Teaching Point 2****Describe the Constellation of 24 GPS Satellites**

Time: 5 min

Method: Interactive Lecture

---

**THE CONSTELLATION OF 24 GPS SATELLITES**

There are more than 24 GPS satellites in orbit. Satellites are constantly being moved or replaced, either temporarily or permanently. However, at any given time, 24 of the satellites are in service.

**ORBIT CHARACTERISTICS**

The 24 GPS satellites' circular 20 200 km orbits are inclined 55 degrees with respect to Earth's equator. The satellites complete an orbit every 12 hours and rise 4 minutes earlier each day, which adds up to 24 hours in a year. This is necessary because Earth orbits the Sun once a year and, to keep accurate time, the satellite must not change orbital position in the course of a year, relative to the stars.

**STATION-KEEPING MANOEUVRES**

Once per year each satellite requires a station-keeping manoeuvre, also referred to as repositioning, to move the satellite back to its original orbital position. The satellites have a tendency to drift from their assigned orbital positions. One reason for this is the gravitational pull of the Earth, Moon and Sun. These manoeuvres require, on average, 12 hours of unusable time for each satellite.

**ON-BOARD GPS EQUIPMENT**

In addition to the radio transmitters required to communicate with the user's GPS receivers on at least two separate frequencies, a GPS satellite will usually also have:

- accurate clocks and computers for generation of coded timing signals,
- radio receivers and transmitters to communicate with the earth-based MCS,
- antennas for the radio equipment,
- rocket thrusters for orbital location and attitude adjustments,
- propellant tanks for the thrusters engines,
- computers for controlling the thrusters engines,
- solar panels to power on-board electrical equipment, and
- batteries for storing the electrical power.

---

**CONFIRMATION OF TEACHING POINT 2**

---

**QUESTIONS**

- Q1. How many GPS satellites are in orbit?
- Q2. What is the shape of a GPS satellite orbit?
- Q3. What is a station-keeping manoeuvre for?

**ANTICIPATED ANSWERS**

- A1. More than 24.

A2. Circular.

A3. To move the satellite back to its original orbital position after it drifts.

---

### Teaching Point 3

### Describe the Network of Earth-Based Control Stations

Time: 5 min

Method: Interactive Lecture

---

#### THE NETWORK OF EARTH-BASED CONTROL STATIONS

The GPS satellite orbits are exact and the satellites are constantly monitored. Radar is used to check each satellite's exact altitude, position and speed. Errors are called "ephemeris errors" because they affect the satellite's orbit or "ephemeris." These errors are caused by gravitational pulls from the moon and sun and by the pressure of solar radiation on the satellites. The errors are usually very slight but they must be corrected to achieve the required accuracy.



Show the cadets Figure 15AA-1.

The control component of GPS consists of five monitor stations, three ground antennas and one MCS. The monitor stations passively track all satellites in view, accumulating ranging data. This information is passed to the MCS where it is processed to determine satellite orbits and to update each satellite's navigation message. Updated information is transmitted to each satellite via the ground antennas.

#### FIVE MONITOR STATIONS

The five monitor stations are located at:

- Hawaii, in the eastern Pacific Ocean,
- Kwajalein, in the western Pacific Ocean's Marshall Islands east of Hawaii,
- Ascension Island, in the south Atlantic Ocean,
- Diego Garcia, in the Indian Ocean, and
- Colorado Springs, in central USA.

#### THREE GROUND ANTENNAS

The three ground antennas are at Ascension Island, Diego Garcia and Kwajalein. These are necessary for transmitting control signals from the MCS to the satellites.

#### THE MASTER CONTROL STATION (MCS)

The MCS is located at the US Schriever AFB in Colorado. Only the MCS communicates with the GPS satellites, using the three ground antennas at Ascension Island, Diego Garcia and Kwajalein.

---

### CONFIRMATION OF TEACHING POINT 3

---

#### QUESTIONS

Q1. In which US state is the MCS located?

- Q2. What do monitor stations do?  
Q3. Name the location of one ground antenna.

### **ANTICIPATED ANSWERS**

- A1. Colorado.  
A2. The monitor stations passively track all satellites in view, accumulating ranging data.  
A3. Ascension Island, Diego Garcia, or Kwajalein.

---

### **Teaching Point 4**

### **Describe the User Receivers**

Time: 15 min

Method: Interactive Lecture

---

### **GPS USER RECEIVERS**

By obtaining a GPS receiver, users automatically get the use of the space component and the control components of the system. GPS receivers are designed and built to interact correctly with the space and control components of GPS. All GPS receivers have an almanac programmed into their computers that tells them where in the sky each satellite is, moment by moment. It only remains to measure how far away the satellites are and then the receiver can calculate its own location.

### **TIME CORRECTION FOR THE USER RECEIVER**

As well as extremely accurate timing, the GPS receiver must have one critical piece of information to measure the distance to a satellite – the exact time on the satellite's clock. The speed of light is so great, and the travel time of the radio signal is so short, that the clock in the GPS satellite and the clock in the GPS receiver must be synchronized perfectly. This requirement, and the degree of accuracy necessary, is a formidable challenge. The method that was used to accomplish this feat involves high-speed computer processing combined with additional data from a fourth GPS satellite.

If the GPS receiver's clocks and the GPS satellite's clocks are perfectly synchronized to universal time, then all the satellite ranges would intersect at a single point (which is the position of the receiver). With imperfect clocks such as those found in the real world, a measurement taken from a fourth GPS satellite, done as a crosscheck, will not intersect with the first three. Since any offset from universal time will affect all measurements equally, the GPS receiver's computer searches for a single correction factor. The correction factor that the receiver must find is the one that it can subtract from all its timing measurements to cause them to intersect at a single point – the location of the receiver. This solution is accomplished by high-speed computing. Once the correction factor is found, the receiver will know not only its own location, but also the precise time on all the satellite's clocks.

### **USER RECEIVER APPLICATIONS**

Many uses for GPS have been found, but there are five main categories: locating, navigating, tracking, mapping, and timing.

#### **Locating**

The first and most obvious application of GPS receivers is the determination of a position or location. A GPS receiver is the first positioning system to offer highly precise location data for any point on the planet, in any weather. That alone would be enough to qualify it as an important tool, but GPS accuracy makes it useful in special applications.

Besides just identifying a location, an exact reference locator is sometimes needed for extremely precise scientific work. When a GPS receiver was used to measure Mount Everest, the data collected improved past work, but also revealed that the mountain is getting taller.

### Navigating

By providing more precise navigation tools and accurate landing systems, a GPS receiver not only makes flying safer, but also more efficient. With precise point-to-point navigation, a GPS receiver saves fuel and extends an aircraft's range by ensuring pilots do not stray from the most direct routes to their destinations.

### Tracking

Tracking is the process of monitoring something as it moves from one location to another. Commerce relies on fleets of vehicles to deliver goods and services either across a city or across a nation. Effective fleet management has important implications, such as telling a customer when a package will arrive, spacing buses for the best-scheduled service, directing the nearest ambulance to an accident, or helping tankers avoid hazards.

A GPS receiver used in conjunction with communication links and computers can provide the backbone for systems tailored to applications in agriculture, mass transit, urban delivery, public safety, and vessel and vehicle tracking. So it is no surprise that police, ambulance, and fire departments have adopted GPS to pinpoint both the location of the emergency and the location of the nearest response vehicle on a computer map. With this clear visual picture of the situation, dispatchers can react immediately and confidently.

### Mapping

Using a GPS receiver to survey and map precisely saves time and money. A GPS receiver makes it possible for a single surveyor to accomplish in a day what used to take weeks with an entire team. Even at that faster speed surveyors can do their work with a higher level of accuracy than was possible without a GPS receiver.

Mapping is the art and science of using a GPS receiver to locate items, then create maps and models of everything in the world: mountains, rivers, forests and other landforms, roads, routes, and city streets as well as precious minerals and resources.



*The Longitude of Greenwich* describes some of the problems that prevent GPS technology from meshing perfectly with the standard maps that are used throughout the world. Even Britain's Royal Observatory was stumped. Details of this Prime Meridian location puzzle can be found at the Royal Observatory website <http://www.nmm.ac.uk/server/show/conWebDoc.416>.

The accuracy of GPS receivers can reveal serious problems with standard mapping methods and that can cause problems that are not easy to solve. One case involves the Prime Meridian.

The problem: Why does a GPS receiver operating on the zero meridian at Greenwich indicate a longitude differing by about 100 m from zero?



Show the cadets Figure 15AB-1.

The Prime Meridian was defined, in classical navigation and map-making, to be the line of longitude passing through Greenwich in England. All other lines of longitude were measured relative to this meridian, which was

originally established to be 0 degrees. That was how the International Date Line came to be on the opposite side of the earth, at 180 degrees longitude in the middle of the Pacific Ocean.

However, longitudes, latitudes and heights in the system that the GPS uses are all measured relative to a theoretical spheroid that best fits mean sea level over the whole globe. While this represents a level of accuracy that was unavailable to previous generations of cartographers (map-makers), the difference of 100 m in the location of the Prime Meridian obviously poses a problem for today's surveyors and cartographers.

When using a GPS receiver in conjunction with standard maps, it is possible to find significant conflicts between the two systems. The information from a GPS receiver will be precisely accurate, but the information it provides can be confusing when used with a standard map.

### **Timing**

Although a GPS receiver is well known for navigation, tracking, and mapping, it is also used to disseminate precise time, time intervals, and frequency. Time is a valuable resource and knowing the exact time is more valuable still. Knowing that a group of timed events is perfectly synchronized is often very important. A GPS receiver makes synchronization and coordination easy and reliable.

There are three fundamental ways time is used. As a universal marker, time tells us when things happened or when they will happen. As a way to synchronize people, events and other types of signals, time helps keep the world on schedule. As a way to tell how long things last, time provides an accurate, unambiguous sense of duration.

---

## **CONFIRMATION OF TEACHING POINT 4**

---

### **QUESTIONS**

- Q1. What critical piece of information does a GPS receiver need to find to calculate its position?
- Q2. What are the five main categories of GPS applications?
- Q3. Why must a GPS receiver always calculate a correction factor for its internal clock?

### **ANTICIPATED ANSWERS**

- A1. The exact time on the satellite's clock.
- A2. Locating, navigating, tracking, mapping, and timing.
- A3. All clocks are imperfect and the GPS must have time that is perfectly synchronized with the GPS satellite.

---

## **END OF LESSON CONFIRMATION**

---

### **QUESTIONS**

- Q1. What are the three components of the GPS?
- Q2. How many GPS satellites are in orbit?
- Q3. In which US state is the MCS located?

### **ANTICIPATED ANSWERS**

- A1. Satellites, control stations, and receivers.
- A2. More than 24.

A3. Colorado.

---

**CONCLUSION**

---

**HOMEWORK/READING/PRACTICE**

N/A.

**METHOD OF EVALUATION**

N/A.

**CLOSING STATEMENT**

Few pieces of information are as useful as a clear and precise description of one's location. GPS describes location, trajectory and speed of any object of interest, making GPS service invaluable to transportation, industry and commerce – as well as leisure pursuits.

**INSTRUCTOR NOTES/REMARKS**

N/A.

---

**REFERENCES**

---

- A2-041 B-GL-382-005/PT-001 Canadian Forces. (2006). *Maps, Field Sketching, Compasses and the Global Positioning System*. Ottawa, ON: Department of National Defence.
- C3-243 US Naval Observatory. (2008). *USNO GPS Timing Operations*. Retrieved February 10, 2008, from <http://tycho.usno.navy.mil/gps.html>.
- C3-244 Trimble Navigation Limited. (2006). *GPS Tutorial*. Retrieved February 10, 2008, from <http://www.trimble.com/gps/index.shtml>.

THIS PAGE INTENTIONALLY LEFT BLANK





**ROYAL CANADIAN AIR CADETS**  
**PROFICIENCY LEVEL THREE**  
**INSTRUCTIONAL GUIDE**



**SECTION 10**

**EO C340.08 – DESCRIBE ASPECTS OF THE INTERNATIONAL SPACE STATION (ISS)**

---

Total Time: 30 min

---

**PREPARATION**

---

**PRE-LESSON INSTRUCTIONS**

Resources needed for the delivery of this lesson are listed in the lesson specification located in A-CR-CCP-803/PG-001, Chapter 4. Specific uses for said resources are identified throughout the instructional guide within the TP for which they are required.

Review the lesson content and become familiar with the material prior to delivering the lesson.

Create a slide of Annex AC.

**PRE-LESSON ASSIGNMENT**

N/A.

**APPROACH**

An interactive lecture was chosen for this lesson to orient the cadets to aspects of the ISS, to generate interest, and emphasize the teaching points.

---

**INTRODUCTION**

---

**REVIEW**

N/A.

**OBJECTIVES**

By the end of this lesson the cadet shall have described aspects of the ISS.

**IMPORTANCE**

It is important for cadets to describe aspects of the ISS in order to understand the scope of international cooperation involved, the size of the project and the mission capability of the ISS.

**Teaching Point 1****Describe the Major Components of the ISS**

Time: 15 min

Method: Interactive Lecture

**MAJOR COMPONENTS OF THE ISS**

The ISS is a large-scale project which requires international cooperation. Major contributors include the United States through National Aeronautics and Space Administration (NASA); Canada through the Canadian Space Agency (CSA); Britain, France, Germany, and Spain through the European Space Agency (ESA); Italy through the Italian Space Agency; Japan through Tsukuba Space Centre; and Russia through Roscosmos.

Each of these contributors has been responsible for the funding and construction of the major components of the ISS.

Construction of the ISS was started in 1998 and is scheduled to be completed by 2010.



Images of the ISS and its individual modules can be viewed at the NASA website. Each of the modules described here are cylindrical in shape and are connected either to each other or to one of the nodes.

Show slide of Annex AC. If a model is available, it should be used as well.



National Aeronautical and Space Administration, *STS-118 Build the Station, Build the Future*, NASA (p. 54)

Figure 15-10-1 Space Shuttle *Endeavour* (STS-118) After Undocking From the ISS

**Zarya**

Zarya (sunrise) was the first module of the ISS to be launched. It was also the first Russian contribution. The module is used primarily for storage, though its original purpose was to provide power, communications and orientation control while waiting for the Zvezda module.

## Unity

The Unity Node is a connecting passageway to living and work areas of the ISS. This was the second ISS module and the first US contribution.

## Zvezda

The Zvezda Service Module serves as the cornerstone for the first habitable sections of the ISS. The module provided the early living quarters, life support, electrical power distribution, data processing, flight control system and propulsion system. Launched in July 2000, this module has already undergone updates to both hardware and software. This was the second Russian contribution to the ISS.

## Harmony

The Harmony Node increases the living and workspace of the ISS by 500 cubic metres. It is a passageway between the three station science facilities (Destiny, Kibo and Columbus), and provides a platform for the Multi-Purpose Logistics Modules, the transfer vehicle, the mating adaptor for the shuttle, and the Canadarm2. This was a US contribution.

## Destiny

Destiny is the US laboratory attached to the ISS. Destiny's interior is modular in design so that as mission requirements change, modules can be added or removed. At maximum capacity, Destiny is expected to hold 13 experiments focusing on human life sciences, materials research, Terran observations and commercial applications.

One feature of Destiny which has affected life on earth already is its window. From here, high quality photos and videos of earth can be taken, such as those used for BBC's documentary productions *Blue Planet* and *Planet Earth*.

## Multi-Purpose Logistics Modules (MPLMs)

Three MPLMs were constructed by the Italian Space Agency to assist in the transportation of materiel to and from the ISS. The modules are pressurized and are designed to be carried inside the shuttle bay during launch and recovery. Once in space, the shuttle will dock with the ISS and use its Canadarm to transfer the MPLM to a docking port on the ISS. Crew from the ISS will transfer goods to and from the MPLM. Once the transfer is complete the MPLM will return to earth onboard the shuttle.

The three MPLMs are named after famous Italians:

- MPLM Leonardo, named after Leonardo da Vinci;
- MPLM Donato, named after Donato di Niccolo Di Betto Bardi (aka Donatello);
- MPLM Raffaello, named after Raffaello Sanzio (aka Raphael).

## Kibo

A Japanese contribution, Kibo (hope) is a scientific research facility. It includes two laboratory facilities, two logistics modules, a Remote Manipulator System, and an Inter-Orbit Communication System. Experiments in Kibo focus on space medicine, biology, Terran observations, material production, biotechnology and communications research.

## Columbus

Built in Germany, Columbus is the ESA's largest contribution to the ISS. Columbus is a research laboratory which will expand the research facilities of the ISS. It is attached to the Harmony Node, as well as the Destiny

and Kibo research labs. Experiments focus on life sciences, materials sciences, fluid physics, and other research in a weightless environment which cannot be conducted on earth.

Two unique aspects of Columbus include:

- remote access to experiments, allowing researchers on earth to coordinate with the station crew to conduct experiments; and
- the ability to conduct experiments in the vacuum of space at any of the four exterior mounting platforms.

### **Automated Transfer Vehicles (ATVs)**

In 2008, the ESA started construction on the first of at least seven ATVs. The ATV is designed to be an unpiloted cargo carrier, which will supply the ISS with liquid and dry cargo as well as gases. It has a substantially greater cargo capacity than the Russian *Progress* cargo carrier, which currently delivers cargo to the ISS. Its secondary duty is as a garbage scow, collecting garbage from the ISS.

### **The Mobile Servicing System (MSS)**

The MSS is a robotic system that plays a key role in the assembly and maintenance of the ISS. It moves equipment and supplies around the exterior of the station, supports astronauts during extravehicular activity (EVA), and services instruments and modules attached to the ISS.

The MSS is composed of three parts, all contributed by Canada. They are:

- **Canadarm 2.** The next generation of the Canadarm located in the space shuttle, Canadarm 2 has improved agility, increased size and capabilities, and is not fixed to one position.
- **Mobile Base System.** The mobile base system is a work platform, which moves along rails attached to the outside of the ISS. This provides the Canadarm 2 with lateral mobility along the main trusses of the ISS.
- **Special Purpose Dexterous Manipulator (Dextre).** Dextre is a two armed robot, which may be attached to the Canadarm 2. Its purpose is to handle delicate assembly tasks currently conducted by astronauts.

---

## **CONFIRMATION OF TEACHING POINT 1**

---

### **QUESTIONS**

- Q1. Which was the first ISS module to be launched?
- Q2. Which three modules are research facilities on the ISS?
- Q3. What is Canada's contribution to the construction of the ISS?

### **ANTICIPATED ANSWERS**

- A1. Zarya.
- A2. Destiny, Kibo and Columbus.
- A3. The MSS.

---

**Teaching Point 2****Discuss ISS Missions**

Time: 10 min

Method: Interactive Lecture

---

**ISS MISSIONS**

The main role of the ISS is to be a research facility. Once construction of the ISS is complete, scientists from the various contributing space agencies will be able to conduct hundreds of experiments from many fields of study.

**Materials International Space Station Experiment (MISSE)**

The MISSE will test the durability of hundreds of samples ranging from lubricants to solar cell technologies. The samples are better engineered to withstand the Sun, extreme temperatures and other elements. They will be attached to the exterior of the ISS, taking them outside of the protection of the Earth's atmosphere. By examining how the materials fare in space, researchers will be able to develop new materials for use in spacecraft as well as make materials that can last longer on Earth.

One example of where this research will be used on Earth is in exterior paint. Materials in space are subjected to more ultra-violet radiation (responsible for paint degradation) than materials on Earth. By applying the knowledge gained in these experiments, paint producers can create paint, which will last longer.

**Minus Eighty Degrees Celsius Laboratory Freezer for ISS (MELFI)**

MELFI is a large freezer onboard the ISS. It uses nitrogen gas (N<sub>2</sub>) as the freezing agent. The purpose of MELFI is to store biological and life sciences samples at controlled temperatures. These temperatures range from 10 degrees Celsius to 99 degrees below 0 Celsius. Samples may include blood, urine, or plants.

**Synchronized Position Hold, Engage, Reorient, Experimental Satellites (SPHERES)**

SPHERES are spherical satellites the size of a bowling ball. They will be used inside the ISS to test a set of instructions which will be used by spacecraft performing autonomous rendezvous and docking manoeuvres. Three free-flying SPHERES will perform formation flying inside the cabin of the ISS. Each of these satellites is self-contained with power, propulsion, computers and navigation equipment. The results of this study will be used for satellite servicing, vehicle assembly and determining formations for spacecraft to fly.

**Online Viewing of ISS Missions on NASA TV**

It is possible to view the ISS missions through online streaming video at the NASA website. Most of the video is archived footage, however live footage is aired during scheduled broadcasts. NASA TV is accessible on the NASA website at <http://www.nasa.gov>.

---

**CONFIRMATION OF TEACHING POINT 2**

---

**QUESTIONS**

- Q1. What will researchers be able to do with the data gained from MISSE?
- Q2. What will the results of SPHERES be used for?
- Q3. Where can one go to view NASA TV?

**ANTICIPATED ANSWERS**

- A1. Researchers will be able to develop new materials for use in spacecraft as well as make materials that can last longer on earth.

A2. The results of this study will be used for satellite servicing, vehicle assembly and determining formations for spacecraft to fly.

A3. NASA TV is accessible on the NASA website at <http://www.nasa.gov>.

---

### END OF LESSON CONFIRMATION

---

#### QUESTIONS

Q1. What are the two Russian contributions to the ISS?

Q2. Which Italian contribution will be used to assist the space shuttle in delivering cargo to the ISS?

Q3. Which two vehicles, other than the space shuttle, are used for transporting goods to and from the ISS?

#### ANTICIPATED ANSWERS

A1. Zarya and Zvezda modules.

A2. The MPLMs (Leonardo, Donato, and Raffaello).

A3. The Russian *Progress* and the ATVs.

#### HOMEWORK/READING/PRACTICE

N/A.

#### METHOD OF EVALUATION

N/A.

#### CLOSING STATEMENT

The ISS is a major step forward for humanity. Not only does it allow for scientific research of space, but it represents collaboration between the different nations of man. Resources that may otherwise be used in conflict are being used to further humanity's knowledge and abilities.

#### INSTRUCTOR NOTES/REMARKS

A model of the ISS would make an ideal visual aid for this lesson. Scale models may be purchased through online sources or ordered at the local hobby store.

In lieu of a model, a large poster would make a great visual aid. Images and multimedia are available through online sources, including NASA.

---

#### REFERENCES

---

C3-245 NASA. (2008). *International Space Station*. Retrieved February 10, 2008, from [http://www.nasa.gov/mission\\_pages/station/main/index.html](http://www.nasa.gov/mission_pages/station/main/index.html).

C3-246 NASA. (2008). *NASA TV*. Retrieved February 12, 2008, from <http://www.nasa.gov/multimedia/nasatv/index.html>.



**ROYAL CANADIAN AIR CADETS**  
**PROFICIENCY LEVEL THREE**  
**INSTRUCTIONAL GUIDE**



**SECTION 11**

**EO C340.10 – IDENTIFY ONLINE STARGAZING PROGRAMS**

---

Total Time: 30 min

---

**PREPARATION**

---

**PRE-LESSON INSTRUCTIONS**

Resources needed for the delivery of this lesson are listed in the lesson specification located in A-CR-CCP-803/PG-001, Chapter 4. Specific uses for said resources are identified throughout the instructional guide within the TP for which they are required.

Review the lesson content and become familiar with the material prior to delivering the lesson.

Visit the SkyView and SKY-MAP.ORG websites and navigate through the various databases presented.

Create slides of Annexes AD and AE.

Photocopy the handout located at Annex AF for each cadet.

**PRE-LESSON ASSIGNMENT**

N/A.

**APPROACH**

An interactive lecture was chosen for this lesson to orient the cadets, generate interest, present background material, and clarify online stargazing.

---

**INTRODUCTION**

---

**REVIEW**

N/A.

**OBJECTIVES**

By the end of this lesson the cadet should be expected to identify two online stargazing programs.

**IMPORTANCE**

It is important for cadets to identify online stargazing programs because online stargazing supports amateur astronomy. When weather and background light make outdoor viewing impossible, these programs make stargazing possible.

**Teaching Point 1****Discuss NASA's SkyView**

Time: 5 min

Method: Interactive Lecture

**NASA'S SKYVIEW**

SkyView is a virtual observatory on the Internet, which generates images of any part of the sky.

SkyView takes observations that other astronomers have made and uses them to create an image of the celestial target of interest. The user must specify which survey or surveys to use.

**How to Access SkyView**

Show the cadets Figure 15AD-1.

1. Type the URL <http://skyview.gsfc.nasa.gov/> in the address field on the Internet.
2. On the SkyView home page, select the Non-Astronomers page using a blue button found halfway down the page, on the left side of the screen.



Show the cadets Figure 15AD-2.

3. Choose the SkyView Query Form button. Access an interactive form to select the desired view of the sky. There are, at a minimum, two required parameters:
  - a. the celestial coordinates of the sky to be viewed or the object's name, and
  - b. the database to be accessed for creating the view.



The celestial coordinate system describes an object's position as right ascension and declination.

**Right Ascension.** This is comparable to longitude on the earth, but measured in hours, minutes and seconds.

**Declination.** This is comparable to latitude on the earth, measured in degrees.



The easiest way to determine coordinates is to visit [SKY-MAP.ORG](http://SKY-MAP.ORG); details of which are explained in the next TP. If the desired target is known, put it in the SkyView Query Form.





Show the cadets Figure 15AD-3.

NGC 4030, a galaxy in the constellation Virgo, was entered as the target in the text box, the image returned is shown in Figure 15AD-3.

The target is the object or area of interest – the name or position of a star, galaxy or nebula, or perhaps the coordinate position of some newly discovered object. Specify the position as a target name, for example, 3C273, M31 or ‘Crab Nebula’, or by using celestial coordinates.

SkyView cannot be used to look at images of objects in our solar system such as planets, asteroids or comets. SkyView is for deep space only.

### SkyView’s Non-Astronomers Page



Show the cadets Figure 15AD-4.

With SkyView, one can look at the sky in many different wavelengths of light. This includes the optical light that people see, along with the invisible radio, infrared, X-ray and gamma-ray data. Different kinds of objects show up in these different regimes; that is, the sky looks very different at radio wavelengths than in the optical. The Non-Astronomers page discusses each in turn, working down from the most energetic radiation, gamma-ray, through visible light and down to the radio spectrum.

The table shown in the Non-Astronomers page gives a quick overview of what can be seen in each regime and suggests a survey and image size for each. These suggested sizes are generally quite close to the defaults, which are useful for cadets who have no image size preference.

Databases accessible from SkyView are explained on the Non-Astronomers page, and include:

- EGRET >100 MeV Gamma-ray wavelengths
- PSPC 2Deg-Int X-ray wavelength
- EUVE 83 Extreme Ultraviolet (EUV) wavelength
- DSS Optical wavelength
- 2MASS K, or IRIS 100 Infrared (IR) wavelength
- FIRST or 1420 MHz Radio wavelength



While not all cadets will want to pursue these various databases, those that do will find adequate explanations on the Non-Astronomers page. Cadets should be encouraged to take advantage of NASA’s explanations of the databases and how to use them.

---

**CONFIRMATION OF TEACHING POINT 1**

---

**QUESTIONS**

- Q1. What is NASA's SkyView?
- Q2. Where can more information about operating SkyView be found?
- Q3. What two parameters are required to operate SkyView?

**ANTICIPATED ANSWERS**

- A1. SkyView is a virtual observatory on the Internet, which generates images of any part of the sky.
- A2. On SkyView's Non-Astronomers page.
- A3. The coordinates of the sky to be viewed and the database to be accessed.

---

**Teaching Point 2****Discuss SKY-MAP.ORG**

Time: 5 min

Method: Interactive Lecture

---

**SKY-MAP.ORG**

SKY-MAP.ORG is an interactive information-management system, which encompasses the entire universe. The basic element of the system is a detailed map of the sky that depicts more than half a billion celestial objects. Instructions are provided on the display. No additional instructions are necessary to browse the map or change its scale.

By using the smallest scale, the whole sky can be viewed at once. Using the largest scale, tiny areas with distant and extremely dim celestial objects, such as distant galaxies, can be viewed – courtesy of the Hubble Space Telescope (HST).

**Purpose**

SKY-MAP.ORG, according to its Ontario-based creators, is an attempt to show the beauty of the universe to everybody – to small children and their parents, the amateur astronomer and the professional astrophysicist.

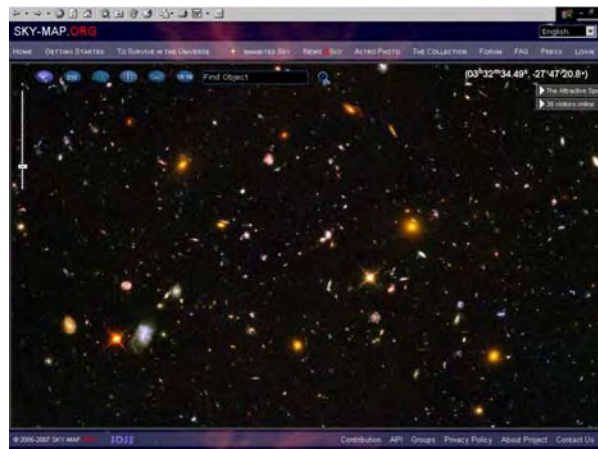

SKY-MAP.ORG, 2008, "SKY-MAP.ORG". Retrieved March 19, 2008, from <http://sky-map.org/>

Figure 15-11-1 The View From the Hubble Space Telescope



Show the cadets Figure 15AE-1.

### How to Access SKY-MAP.ORG

1. Type <http://sky-map.org> in the address field on the Internet.
2. On the first screen presented, click on the “Home” button above the top of the star-field and the full universe, seen from Earth, will be shown.

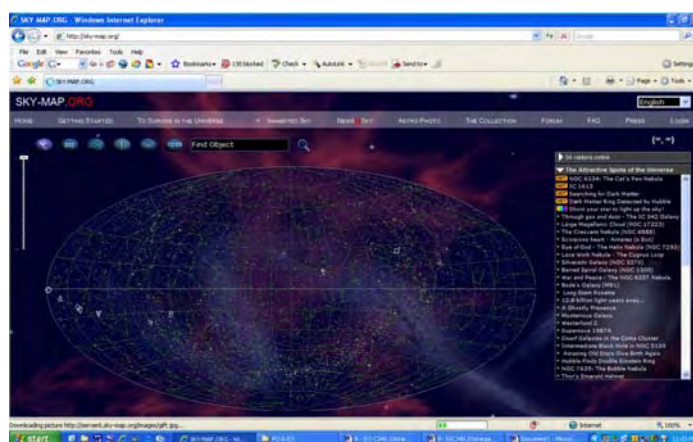

SKY-MAP.ORG, 2008, “SKY-MAP.ORG”. Retrieved March 19, 2008, from <http://sky-map.org/>

Figure 15-11-2 SKY-MAP.ORG Home Page



Show the cadets Figure 15AE-2.

## CONFIRMATION OF TEACHING POINT 2

### QUESTIONS

- Q1. What is SKY-MAP.ORG?
- Q2. Where are operating instructions for SKY-MAP.ORG found?
- Q3. Where is SKY-MAP.ORG based?

### ANTICIPATED ANSWERS

- A1. SKY-MAP.ORG is an interactive information-management system which encompasses the entire outer space.
- A2. Instructions are provided on the display.
- A3. Ontario.

**Teaching Point 3****Explain the SKY-MAP.ORG User Interface**

Time: 15 min

Method: Interactive Lecture

**THE SKY-MAP.ORG USER INTERFACE**

When using SKY-MAP.ORG, the browsing area of the screen portrays the selected view of the sky.



Show the cadets Figure 15AE-3.

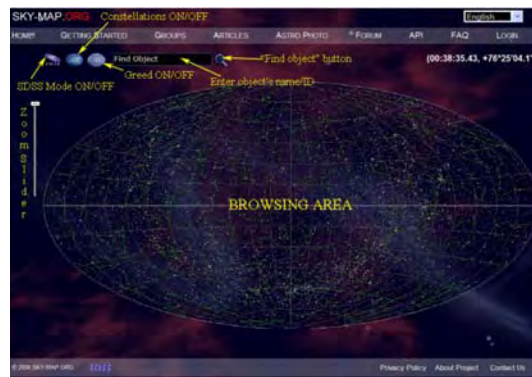

SKY-MAP.ORG, 2008, "SKY-MAP.ORG". Retrieved March 19, 2008, from <http://sky-map.org/>

Figure 15-11-3 SKY-MAP.ORG Instruction Page

**PROGRAM CONTROL FEATURES**

Placing the mouse cursor over a button without clicking reveals the purpose of the control button at the top of the browsing area. As the program becomes more sophisticated, new buttons will be added. The basic controls needed to navigate are shown in Figure 15-11-3. The "Home" button returns the program to the home page showing the entire night sky as seen from the Solar system.

SKY-MAP.ORG offers two different browsing modes:

- Normal Mode, and
- Sloan Digital Sky Survey (SDSS) Mode.

**Normal Mode**



Show the cadets Figure 15AE-4.

The image in this figure shows the sky in Normal Mode. When in Normal Mode, SKY-MAP.ORG can access various databases to display the desired fields of view.

In the example shown, a planar projection of the whole sky is seen. Pointing the mouse at any object inside the browsing area will cause an information window to automatically appear, providing basic scientific data about the object. Left-clicking on the zoom slider causes the scale of the sky map to be changed, thereby altering the detail of the browsing area.



SKY-MAP.ORG, 2008, "SKY-MAP.ORG". Retrieved March 19, 2008, from <http://sky-map.org/>

Figure 15-11-4 SKY-MAP.ORG Normal Mode

In this figure, the scale has been changed to a higher magnification so that only a portion of the sky can be viewed. The scale can be enlarged again using the zoom slider, to view very faint objects.

### An Object's Basic Information Window (BIW)

If the mouse cursor is close enough to an object (or on an object), its BIW appears, showing the data about the object. The basic data includes ID, names, constellations, exact coordinates, distances from Earth and apparent magnitudes. Left-clicking once while the BIW is still open, causes the object page to open. An object page contains detailed information about its star. In addition an object page displays all photo images where the star is present, articles and all external links about the star.

To view the stars at this moment, use the button provided with the correct time shown. When the button is pushed, the program asks for the user's location. When the user enters the name of the closest town or the latitude and longitude, the star field that is overhead will be presented. This feature only works in Normal Mode, not in SDSS Mode.

### SDSS Mode



Show the cadets Figure 15AE-5.

This figure shows a view of the browsing area in SDSS mode. In this case, SKY-MAP.ORG has found galaxy NGC 4030 in constellation Virgo. NGC 4030 is at celestial coordinates:

- Right ascension: 12 hours 00 minutes 23.40 seconds
- Declination: -01°06'03.0"



SKY-MAP.ORG, 2008, "SKY-MAP.ORG". Retrieved March 19, 2008, from <http://sky-map.org/>

Figure 15-11-5 Spiral Galaxy in SDSS Mode

When online, the photographic plate can be found by entering the name NGC 4030 into the "Find Object" text box or by entering the coordinates as right ascension followed by a comma and then declination. If coordinates are entered, however, considerable magnification must be applied to see NGC 4030. At this scale, it is only magnitude 0, appearing as a bright star.



Star brightness is called magnitude. The lower the magnitude, the brighter the object. The brightest star visible in the night sky is Sirius, classified as a magnitude of  $-1$ .

Sirius, the brightest star, is found at coordinates 06 45 08.90, -16 42 58.0 in Normal Mode. SDSS does not currently cover this part of the sky, but many astro photos of Sirius can be located through Sirius' BIW.

### Navigating in Normal Mode

Normal Mode uses a drag-and-drop operation to shift the sky in the browsing area. To move the browsing area, place the mouse in the browsing area without pointing at any object. Press and hold the left button of the mouse and move the mouse – the star field will move with the mouse cursor.

There are about 500 million stars in the databases. Only a small amount of these stars can be displayed simultaneously in the browsing area at any given period of time. Faint celestial objects (the less bright stars) can be viewed by increasing the scale of the map.



Show the cadets Figure 15AE-6.

This figure is a view, at a large scale, corresponding to high magnification, at the right ascension and declination coordinates shown near the top right corner of the screen.

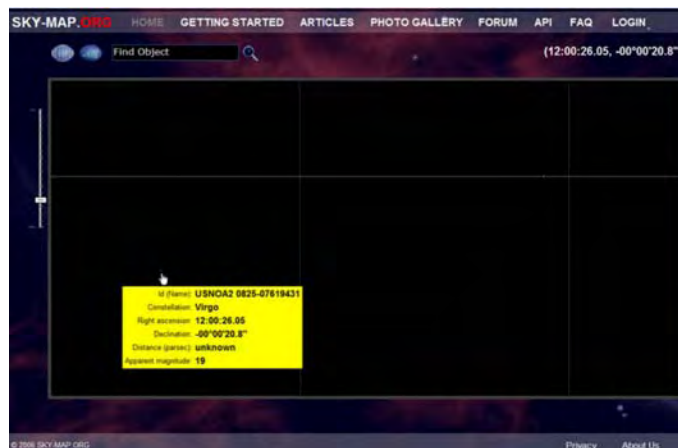

SKY-MAP.ORG, 2006, "SKY-MAP.ORG". Retrieved March 19, 2008, from <http://sky-map.org/>

Figure 15-11-6 Magnitude 19 in Virgo

In the example there are only two stars present in the browsing area. Both objects have a magnitude close to 19. That means these two stars can only be seen with powerful telescopes.

### Photo Gallery

From the main menu, the photo gallery page with photo images can be accessed. The photo gallery index is a view similar to Figure 15AE-7.



SKY-MAP.ORG, 2006, "SKY-MAP.ORG". Retrieved March 19, 2008, from <http://sky-map.org/>

Figure 15-11-7 SKY-MAP.ORG Photo Gallery



Show the cadets Figure 15AE-7.

Each field with yellow borders determines the boundaries of a star field photograph. When the mouse cursor is inside these boundaries, a minimized version of the photograph appears near the pointer. If the mouse cursor points to the area where fields meet, the photographs of all the fields will be displayed. For example, in this figure, the mouse points to the intersection of three different fields. The user can see the minimized versions of all three images. Left-clicking the mouse will change the mode to "Select Image" as shown in the next figure.

 Show the cadets Figure 15AE-8.



SKY-MAP.ORG, 2006, "SKY-MAP.ORG". Retrieved March 19, 2008, from <http://sky-map.org/>

Figure 15-11-8 Image Selection

Clicking on the desired image in Figure 8 will load it as shown in Figure 15-11-9.

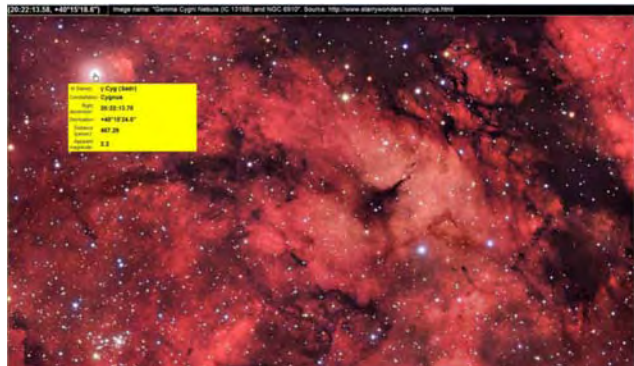

SKY-MAP.ORG, 2006, "SKY-MAP.ORG". Retrieved March 19, 2008, from <http://sky-map.org/>

Figure 15-11-9 Gamma Cygni Nebula Image Selected

 Show the cadets Figure 15AE-9.

Pointing the mouse on an object on the photograph causes the object's BIW to open exactly the same way as it did in the browsing area. Left-clicking on the object loads the object's page. The current coordinates of the mouse will be shown, with the original source directly above it.



## CATALOGUES AND DATABASES AVAILABLE FOR ACCESS

### Infrared Astronomical Satellite (IRAS) Sky Survey

The IRAS conducted a survey of 98 percent of the sky from low Earth orbit during a ten-month period from January to November 1983. The purpose of the survey was to produce an extremely reliable catalogue of infrared point sources at a sensitivity that was unobtainable from within the Earth's atmosphere. The stability of the orbiting IRAS infrared detectors allowed the viewing of extended, or non-point-like, astronomical sources with the IRAS survey data.

### H-Alpha Sky Survey

H-alpha is a particular frequency of radiation associated with hydrogen atoms. Hydrogen is the primary component of celestial nebulae. H-alpha can indicate the shape and size of a gas cloud.

### Astro Photo Survey

SKY-MAP.ORG's Astro Photo Survey is a collection of astronomical photos. Credit is usually given at the top of the individual photo so that the user knows where it originated.

### Sloan Digital Sky Survey (SDSS)

Simply put, the SDSS is the most ambitious astronomical survey ever undertaken. When completed, it will provide detailed optical images covering more than a quarter of the sky, and a three-dimensional map of about a million galaxies and quasars, which are extremely bright, mysterious objects. As the survey progresses, the data is released to the scientific community and general public in annual increments.

The SDSS uses a dedicated, 2.5-metre telescope on Apache Point, New Mexico, equipped with two powerful special-purpose instruments. The 120-megapixel camera can image 1.5 square degrees of sky at a time, about eight times the area of the full moon. A pair of spectrographs fed by optical fibres measure spectra of (and hence distances to) more than 600 galaxies and quasars in a single observation. A custom-designed set of software data pipelines keeps pace with the enormous data flow from the telescope.

This data, as well as more catalogues and additional databases, will be added from time to time to the list of images that SKY-MAP.ORG can access.



Give each cadet a copy of the Astronomy Basics handout located at Annex AF.

---

## CONFIRMATION OF TEACHING POINT 3

---

### QUESTIONS

- Q1. What are the two modes that SKY-MAP.ORG can operate in?
- Q2. In the SKY-MAP.ORG Photo Gallery, what marks the boundaries of a star field photograph?
- Q3. What can be entered into the "Find Object" text box to select a target object?

### ANTICIPATED ANSWERS

- A1. Normal Mode and SDSS Mode.
- A2. Yellow borders.

A3. The object's name or the object's celestial coordinates.

---

**END OF LESSON CONFIRMATION**

---

**QUESTIONS**

- Q1. Where is SKY-MAP.ORG based?
- Q2. What two parameters are required to operate NASA's SkyView?
- Q3. When completed, approximately how much of the sky will be mapped in SDSS Mode?

**ANTICIPATED ANSWERS**

- A1. Ontario.
- A2. The coordinates of the sky to be viewed and the database to be accessed.
- A3. When completed, it will provide detailed optical images covering more than a quarter of the sky.

---

**CONCLUSION**

---

**HOMEWORK/READING/PRACTICE**

N/A.

**METHOD OF EVALUATION**

N/A.

**CLOSING STATEMENT**

Industrialization and the growth of cities has made viewing the sky difficult for the majority of Canadians but online stargazing provides an alternative way to pursue this interesting hobby.

**INSTRUCTOR NOTES/REMARKS**

N/A.

---

**REFERENCES**

---

- C3-230 ET.SKY-MAP. (2008). *SKY-MAP.ORG*. Retrieved February 8, 2008, from <http://sky-map.org/>.
- C3-231 NASA HEASARC. (2008). *SkyView*. Retrieved February 8, 2008, from <http://skyview.gsfc.nasa.gov/>.

## ASTRONAUT MARC GARNEAU



*Canadian Space Agency, 2008, Image Gallery: Marc Garneau (STS-97). Retrieved March 2, 2008, from [http://www.espace.gc.ca/asc/app/gallery/results2.asp?session=&image\\_id=garneau-01](http://www.espace.gc.ca/asc/app/gallery/results2.asp?session=&image_id=garneau-01)*

Figure 15A-1 Astronaut Marc Garneau

## **ASTRONAUT MARC GARNEAU**

Marc Garneau was a Captain (Navy) in the Canadian Forces and was Canada's first astronaut.

### **MISSIONS**

A veteran of three space flights (STS-41G in 1984, STS-77 in 1996 and STS-97 in 2000), Marc Garneau has logged over 677 hours in space.

#### **STS-41G**

Mission: Earth Radiation Budget Satellite (ERBS).

Space Shuttle: *Challenger*.

Launched: October 5, 1984 at 7:03:00 a.m. EDT.

Landed: October 13, 1984 at 12:26:33 p.m. EDT.

Mission Duration: 8 days.

Orbit Altitude: 218 nautical miles.

This was the first flight to include two women, Sally Ride and Kathryn Sullivan. Sullivan was the first American woman to walk in space. The ERBS was deployed less than nine hours into the flight. As well, the Office of Space and Terrestrial Applications-3 (OSTA-3) carried three experiments in the payload bay. Components of Orbital Refueling System (ORS) were connected, demonstrating it is possible to refuel satellites in orbit.

Other payloads were:

- Large Format Camera (LFC),
- IMAX Camera, flying for the third time, and
- Canadian Experiments (CANEX), including:
  - Auroral Photography Experiment (APE),
  - Radiation Monitoring Equipment (RME), and
  - Thermoluminescent Dosimeter (TLD).

#### **STS-77**

Mission: SPACEHAB; SPARTAN Inflatable Antenna Experiment (IAE).

Space Shuttle: *Endeavour*.

Launched: May 19, 1996, 6:30:00 a.m. EDT.

Landed: May 29, 1996, 7:09:18 a.m. EDT.

Mission Duration: 10 days.

Orbit Altitude: 153 nautical miles.

The fourth shuttle flight of 1996 was highlighted by four rendezvous activities with two different payloads. Primary payloads, all located in the cargo bay, were the SPACEHAB-4 pressurized research module, the IAE mounted on a Spartan 207 free-flyer and a suite of four technology demonstration experiments known as Technology Experiments for Advancing Missions in Space (TEAMS).

Using the Canadarm, the Spartan free-flyer (a platform for experiments) was deployed with the 60 kg (132 lbs) IAE antenna structure inflated to its full size of 15 m (50 feet) in diameter—about the size of a tennis court. Potential benefits of inflatable antennas over conventional rigid structures include their lower development costs, greater reliability, and lower mass and volume requiring less stowage space and potentially a smaller launch vehicle.

TEAMS experiments were:

- Global Positioning System (GPS) Attitude and Navigation Experiment (GANE),
- Vented Tank Resupply Experiment (VTRE), and
- Liquid Metal Thermal Experiment (LMTE).

Aquatic Research Facility (ARF) experiments also took place. This was a joint Canadian Space Agency/NASA project that allowed investigation of a wide range of small aquatic species, including starfish, mussels and sea urchins.

### **STS-97**

Mission: International Space Station Assembly Flight 4A.

Space Shuttle: *Endeavour*.

Launched: November 30, 2000, 10:06 p.m. EST.

Landed: December 11, 2000, 6:04 p.m. EST.

Mission Duration: 11 days.

Orbit Altitude: 200 nautical miles.

During their 11-day mission, the astronauts completed three spacewalks and extravehicular activities (EVAs), to:

- deliver and connect the first set of solar arrays to the International Space Station (ISS);
- prepare a docking port for arrival of the US Laboratory Destiny;
- install Floating Potential Probes to measure electrical potential surrounding the station;
- install a camera cable outside the Unity module; and
- transfer supplies, equipment and refuse between *Endeavour* and the station.

On flight day three, *Endeavour* was linked to the ISS while orbiting 200 nautical miles above northeast Kazakhstan. Extravehicular mobility units (EMUs), the Simplified Aid for EVA Rescue (SAFER) units, the Canadarm Remote Manipulator System (RMS), the Orbiter Space Vision System (OSVS) and the Orbiter Docking System (ODS) were all checked. Also, an ODS camera was installed.

From inside *Endeavour*, Mission Specialist Marc Garneau used the Canadarm RMS to remove the P6 truss from the payload bay, manoeuvring it into an overnight park position to warm its components. Shuttle astronauts moved through *Endeavour*'s docking tunnel and opened the hatch to the ISS docking port to leave supplies and computer hardware on the doorstep of the station. On flight day four, the crew entered the Unity module for the first time.

On flight day eight, the STS-97 crew paid the first visit to the Expedition One crew residing in the space station. Until then the shuttle and the station had kept one hatch closed to maintain respective atmospheric pressures, allowing the shuttle crew to conduct their spacewalks and mission goals. After a welcome ceremony

and briefing, the eight spacefarers conducted structural tests of the station and its solar arrays, transferred equipment, supplies and refuse back and forth between the spacecraft.

On flight day nine, the two crews completed final transfers of supplies to the station and other items to be returned to earth. The *Endeavour* crew bade farewell to the Expedition One crew at 10:51 a.m. EST and closed the hatches between the spacecraft. After being docked together for 6 days, 23 hours and 13 minutes, *Endeavour* undocked from the station and made an hour-long, tail-first circle of the station. The undocking took place 204 nautical miles above the border of Kazakhstan and China. The final separation burn took place near the northeast coast of South America.

## **PLACE AND DATE OF BIRTH**

Born February 23, 1949 in Quebec City.

## **EDUCATION**

Marc Garneau's education includes:

- Early education in Quebec City, Saint-Jean-sur-Richelieu in Quebec and in London, England;
- Bachelor of Science degree in Engineering Physics from the Royal Military College of Kingston in 1970;
- Doctorate in Electrical Engineering from the Imperial College of Science and Technology, London, England, in 1973; and
- Attended the Canadian Forces Command and Staff College of Toronto in 1982–1983.

## **PROFESSIONAL EXPERIENCE**

Marc Garneau was a Combat Systems Engineer in HMCS Algonquin from 1974 to 1976. While serving as an instructor in naval weapon systems at the Canadian Forces Fleet School in Halifax in 1976–77, he designed a simulator for use in training weapons officers in the use of missile systems aboard Tribal class destroyers. He served as Project Engineer in naval weapon systems in Ottawa from 1977 to 1980. Garneau returned to Halifax with the Naval Engineering Unit, which troubleshoots and performs trials on ship-fitted equipment, and he helped develop an aircraft-towed target system for the scoring of naval gunnery accuracy. Promoted to Commander in 1982 while at Staff College, Garneau was transferred to Ottawa in 1983 to become design authority for naval communications and electronic warfare equipment and systems. In January 1986, he was promoted to Captain. Garneau retired from the Navy in 1989.

In February 2001, Marc Garneau was appointed Executive Vice President of the Canadian Space Agency. He was subsequently appointed President of the Canadian Space Agency, effective November 22, 2001. He resigned from this position on November 28, 2005, to run for office in a federal election.

## **SPECIAL HONOURS**

Marc Garneau's special honours include:

- Athlone Fellowship,
- National Research Council (NRC) Bursary,
- National Honourary Patron of Hope Air and Project North Star,
- President of the Board of the McGill Chamber Orchestra,
- Officer of the Order of Canada,
- promoted Companion of the Order of Canada,
- named Chancellor of Carleton University,

- recipient of the Prix Montfort en sciences,
- recipient of the Queen Elizabeth II Golden Jubilee Medal,
- recipient of the NASA Exceptional Service Medal,
- recipient of the NASA Space Flight Medals (1984, 1996, 2000),
- recipient of the Canadian Forces Decoration (military),
- co-recipient of the F. W. (Casey) Baldwin Award,
- awarded honorary advanced degrees from:
  - University of Ottawa,
  - Collège militaire royal de Saint-Jean,
  - Université Laval,
  - Technical University of Nova Scotia,
  - Royal Military College,
  - York University, and
  - University of Lethbridge.

## **AFFILIATIONS**

Marc Garneau's affiliations include:

- honorary Fellow of the Canadian Aeronautics and Space Institute,
- member of the Association of Professional Engineers of Nova Scotia,
- member of the Navy League of Canada,
- honorary Member of the Canadian Society of Aviation Medicine, and
- member of the International Academy of Astronautics.

THIS PAGE INTENTIONALLY LEFT BLANK



## ASTRONAUT ROBERTA BONDAR



*Canadian Space Agency, 2008, Image Gallery: Roberta Lynn Bondar. Retrieved March 2, 2008, from [http://www.space.gc.ca/asc/app/gallery/gallery/high/cd\\_01\\_11.JPG](http://www.space.gc.ca/asc/app/gallery/gallery/high/cd_01_11.JPG)*

Figure 15B-1 Astronaut Roberta Bondar

## **ASTRONAUT ROBERTA BONDAR**

Roberta Bondar enjoys flying, hot air ballooning, canoeing, biking, target shooting (rifle, handgun), fishing, cross-country skiing and hiking.

### **MISSIONS**

In early 1990, Roberta Bondar was designated a prime Payload Specialist for the first International Microgravity Laboratory Mission (IML-1).

#### **STS-42**

Mission: IML-1.

Space Shuttle: *Discovery*.

Launched: January 22, 1992, 9:52:33 a.m. EST.

Landed: January 30, 1992, 8:07:17 a.m. PST.

Mission Duration: 8 days.

Orbit Altitude: 163 nautical miles.

The primary payload for STS-42 was the IML-1, making its first flight and using the pressurized Spacelab module. The international crew was divided into two teams for around-the-clock research on the human nervous system's adaptation to low gravity and the effects of microgravity on other life forms such as shrimp eggs, lentil seedlings, fruit fly eggs and bacteria. Materials processing experiments were also conducted, including crystal growth from a variety of substances such as enzymes, mercury iodide and a virus.

Other experiments during STS-42 were:

- Gelation of Sols: Applied Microgravity Research-1 (GOSAMR-1),
- IMAX camera,
- Investigations into Polymer Membrane Processing (IPMP),
- Radiation Monitoring Experiment III (RME III), and
- Shuttle Student Involvement Program (SSIP) experiments.

### **PLACE AND DATE OF BIRTH**

Born December 4, 1945 in Sault Ste. Marie, Ont.

### **EDUCATION**

Roberta Bondar's education includes:

- Elementary and secondary school in Sault Ste. Marie, Ont.,
- BSc in zoology and agriculture from the University of Guelph,
- MSc in experimental pathology from the University of Western Ontario,
- Doctorate in neurobiology from the University of Toronto,
- Doctor of Medicine from McMaster University, and
- Certification in scuba diving and parachuting.

## **PROFESSIONAL EXPERIENCE**

Roberta Bondar was a neurologist and a clinical and basic science researcher in the nervous system. As an undergraduate student she worked for six years for the federal Fisheries and Forestry Department on genetics of the spruce budworm with reference to the visual system. After internship in internal medicine at Toronto General Hospital, she completed post-graduate medical training in neurology at the University of Western Ontario and in neuro-ophthalmology at Tuft's New England Medical Center (Boston) and at the Playfair Neuroscience Unit of Toronto Western Hospital. Bondar was appointed assistant professor of medicine (neurology) in 1982–84 at McMaster University. She specialized in carotid and transcranial ultrasound at the Pacific Vascular Institute, in Seattle, in 1988.

Bondar was one of the six Canadian astronauts selected in December, 1983 and she began astronaut training in February, 1984. In 1985 she was named chairperson of the Canadian Life Sciences Subcommittee for Space Station. She served as a member of the Ontario Premier's Council on Science and Technology. She was a Civil Aviation medical examiner and a member of the scientific staff of Sunnybrook Health Science Centre. As an astronaut, she has conducted research into blood flow in the brain during microgravity, lower body negative pressure and various pathological states.

Roberta Bondar left the Canadian Space Agency effective September 4, 1992, to pursue her research.

## **SPECIAL HONOURS**

Roberta Bondar's special honours include:

- recipient of Ontario Graduate Fellowship,
- recipient of National Research Council (NRC) Scholarship,
- recipient of NRC Postdoctorate Fellowship,
- recipient of Ontario Ministry of Health Fellowship,
- recipient of Medical Research Council Fellowship,
- recipient of Career Scientist Award from the Ontario Ministry of Health,
- honorary member of Zonta International,
- honorary member Canadian Federation of University Women,
- recipient of Vanier Award from the Jaycees of Canada,
- co-recipient of the F. W. (Casey) Baldwin Award,
- honorary life member of Girl Guides of Canada,
- recipient of Senior Fellowship from Ryerson Polytechnical Institute, Toronto, and
- recipient of honorary degrees from:
  - Mount Allison University,
  - Mount St. Vincent University,
  - University of Guelph,
  - Lakehead University,
  - Algoma College,

- Laurentian University,
- Saint Mary's University,
- McMaster University,
- University of Regina,
- University of Calgary,
- University of Ottawa, and
- University of Toronto.

## **AFFILIATIONS**

Roberta Bondar's affiliations include:

- Fellow of the Royal College of Physicians and Surgeons of Canada,
- American Academy of Neurology,
- Canadian Neurological Society,
- Canadian Aeronautics and Space Institute,
- Canadian Society of Aerospace Medicine,
- College of Physicians and Surgeons of Ontario,
- Canadian Stroke Society,
- Aerospace Medical Association,
- Albuquerque Aerostat Ascension Association, and
- American Society for Gravitational and Space Biology.

**ASTRONAUT STEVE MACLEAN**



*Canadian Space Agency, 2008, Image Gallery: Steve MacLean. Retrieved March 2, 2008, from <http://www.espace.gc.ca/asc/app/gallery/results1.asp?session=>*

**Figure 15C-1 Astronaut Steve MacLean**

## **ASTRONAUT STEVE MACLEAN**

Selected as one of the first six Canadian astronauts in December 1983, Steve MacLean began astronaut training in February 1984. From 1987 to 1993 he was the Program Manager for the Advanced Space Vision System (ASVS), a computer-based camera system designed to provide guidance data that enhances the control of both Canadarm and Canadarm2. From 1988 to 1991 he also assumed the role of Astronaut Advisor to the Strategic Technologies in Automation and Robotics (STEAR) Program.

### **MISSIONS**

#### **STS-52**

Mission: U.S. Microgravity Payload-1 (USMP-1); Laser Geodynamic Satellite II (LAGEOS II).

Space Shuttle: Columbia.

Launched: October 22, 1992, 1:09:39 p.m. EDT.

Landed: November 1, 1992, 9:05:53 a.m. EST.

Mission Duration: 9 days.

Orbit Altitude: 163 nautical miles.

The primary mission objectives were the deployment of the LAGEOS-II, a joint effort between NASA and the Italian Space Agency (ASI), and also operation of the USMP-1.

In addition to LAGEOS II and USMP-1, other mission objectives included:

- Canadian experiments, CANEX-2, located in both the orbiter's cargo bay and mid-deck, consisting of:
  - Space Vision System (SVS),
  - Materials Exposure in Low-Earth Orbit (MELEO),
  - Queen's University Experiment in Liquid-Metal Diffusion (QUELD),
  - Phase Partitioning in Liquids (PARLIQ),
  - Sun Photospectrometer Earth Atmosphere Measurement-2 (SPEAM-2),
  - Orbiter Glow-2 (OGLOW-2),
  - Space Adaptation Tests and Observations (SATO), and
  - A small, specially marked satellite, the Canadian Target Assembly, which was deployed on day nine to support SVS experiments; and
- three independent sensors provided by the European Space Agency, including:
  - Modular Star Sensor,
  - Yaw Earth Sensor, and
  - Low Altitude Conical Earth Sensor.

#### **STS-115**

Mission: Installation of the P3/P4 truss arrays on the International Space Station.

Space Shuttle: Atlantis.

Launched: September 9, 2006 at 11:15 a.m. EDT.

Landed: September 21, 2006 at 6:21 a.m. EDT.

Mission Duration: 12 days.

Orbit Altitude: 122 nautical miles.

The STS-115 crew delivered and installed the P3/P4 truss arrays on the ISS. Three spacewalks were carried out to put the new P3/P4 truss in service. Spacewalkers, including Steve MacLean, connected power cables and activated gear readying the P3/P4, and its unfurled solar arrays, for power generation.

The STS-115 and Expedition 13 crews utilized both shuttle and station robotic arms, Canadarm and Canadarm2, during installation activities.

### **PLACE AND DATE OF BIRTH**

Born December 14, 1954, in Ottawa, Ont.

### **EDUCATION**

Steve MacLean's education includes:

- Primary and secondary school in Ottawa,
- Bachelor of Science (Honours) in Physics in 1977 from York University, and
- Doctorate in Physics in 1983 from York University.

### **PROFESSIONAL EXPERIENCE**

From 1974 until 1976 Steve MacLean worked in sports administration and public relations at York University, and competed with the Canadian National Gymnastics Team from 1976 to 1977. He taught part-time at York University, from 1980 until 1983, and then became a visiting scholar at Stanford University. As a laser physicist, MacLean's research included work on electro-optics, laser-induced fluorescence of particles and crystals, and multi-photon laser spectroscopy.

MacLean was the Chief Science Advisor for the International Space Station from 1993 until 1994, when he was appointed Director General of the Canadian Astronaut Program for a two-year period.

In August 1996, MacLean began mission specialist training at the Johnson Space Center in Houston, Texas. After successfully completing basic training in 1998, he continued with advanced training while fulfilling technical duties in the NASA Astronaut Office Robotics Branch. Later, MacLean served as CapCom (Capsule Communicator) for both the ISS Program and the Shuttle Program at the Johnson Space Center.

In 2007, MacLean was Chief Astronaut for the CSA, coordinating the astronaut activities from CSA headquarters.

### **SPECIAL HONOURS**

Steve MacLean's special honours include:

- recipient of the President's Award (Murray G. Ross Award) at York University,
- recipient of a Natural Sciences and Engineering Research Council of Canada (NSERC) Postgraduate Scholarship,
- recipient of two Ontario Graduate Scholarships,

- recipient of a NSERC Postdoctoral Fellowship, and
- recipient of honorary advanced degrees from:
  - Collège militaire royal de Saint-Jean in Que.,
  - York University in Toronto, and
  - Acadia University in Wolfville.



**ASTRONAUT CHRIS HADFIELD**



*Canadian Space Agency, 2008, Image Gallery: Chris Hadfield. Retrieved March 2, 2008, from [http://www.espace.gc.ca/asc/app/gallery/results1.asp?session=&search=0&ListAbsolutePage=8&root\\_categories=0&categories\\_0=0&keywords=Chris|Hadfield&images=ON](http://www.espace.gc.ca/asc/app/gallery/results1.asp?session=&search=0&ListAbsolutePage=8&root_categories=0&categories_0=0&keywords=Chris|Hadfield&images=ON)*

Figure 15D-1 Astronaut Chris Hadfield

## **ASTRONAUT CHRIS HADFIELD**

In June 1992, Chris Hadfield was selected to become one of four new Canadian astronauts from a field of 5 330 applicants. He was assigned by the CSA to the NASA Johnson Space Center in Houston, Texas, in August of the same year where he addressed technical and safety issues for Shuttle Operations Development, contributed to the development of the glass shuttle cockpit, and supported shuttle launches at the Kennedy Space Center in Florida. In addition, Hadfield was NASA's Chief CapCom, the voice of mission control to astronauts in orbit, for 25 space shuttle missions. From 1996 to 2000, he represented CSA astronauts and coordinated their activities as the Chief Astronaut for the CSA.

From 2001 to 2003, Hadfield was the Director of Operations for NASA at the Yuri Gagarin Cosmonaut Training Centre (GCTC) in Star City, Russia. His work included coordination and direction of all ISS crew activities in Russia and oversight of training and crew support staff, as well as policy negotiation with the Russian Space Program and other international partners. He also trained and became fully qualified as a flight engineer cosmonaut in the Soyuz TMA spacecraft to perform spacewalks in the Russian Orlan spacesuit.

Hadfield is a civilian CSA astronaut, having retired as a Colonel from the Canadian Forces in 2003 after 25 years of military service. He was Chief of Robotics for the NASA Astronaut Office at the Johnson Space Center in Houston, Texas from 2003 to 2006, and then Chief of International Space Station Operations.

## **MISSIONS**

### **STS-74**

Mission: Second Shuttle-Mir Docking.

Space Shuttle: Atlantis.

Launched: November 12, 1995 at 7:30:43 a.m. EST.

Landed: November 20, 1995 at 12:01:27 p.m. EST.

Mission Duration: 8 days.

Orbit Altitude: 213 nautical miles.

This mission illustrated the international flavour of the space station effort in both the hardware and the crew. Hardware in the payload bay included:

- Canadian built Remote Manipulator System (RMS) arm,
- U.S. built Orbiter Docking System (ODS),
- Russian-Built Docking Module (DM) and solar array, and
- US/Russian built solar array.

Chris Hadfield was the fourth Canadian to fly on a shuttle but the first Canadian mission specialist. Awaiting Atlantis aboard Mir, were two Russian cosmonauts and a German cosmonaut, along with Russian and European Space Agency research samples and equipment.

On flight day three, Hadfield operated the Canadarm RMS to lift the DM from its stowed position and moved it to within five inches above the ODS in the forward part of the bay. ODS was flown on all Shuttle-Mir docking flights and served as a passageway between two spacecraft. Steering jets were then fired to push Atlantis against the DM. Once mating was confirmed, the Canadarm ungrappled from the DM and hatches between the DM and the ODS were opened.

The manual phase of rendezvous began when Atlantis was about 800 m from Mir. At 51.8 m from Mir, the approach was halted while Mir was manoeuvred into alignment for docking. After permission from flight directors in Moscow and Houston, Atlantis was moved to 9.1 m from Mir and then halted momentarily again to make final adjustments. The key camera for final approach was an elbow camera on the shuttle's Canadarm RMS.

Hatches between Mir and Atlantis were opened at 4:02 a.m. EST, November 15. Control of the DM was transferred to the Mir 20 crew. During mated operations, nearly 453.6 kg of water was transferred to Mir. Numerous experiment samples, including blood, urine and saliva, were moved to the orbiter for return to earth. The shuttle crew also brought gifts, including Canadian maple sugar candies and a guitar (second guitar on Mir). Lithium hydroxide canisters – a late addition – were transferred to Mir in case the faulty environmental control system failed again and the station's air needed to be "scrubbed" clean. The two spacecraft separated on November 18 and Atlantis began the journey home.

### **STS-100**

Mission: International Space Station Assembly Flight 6A.

Space Shuttle: *Endeavour*.

Launched: April 19, 2001, 2:40:42 p.m. EDT.

Landed: May 1, 2001, 9:10:42 p.m. PDT.

Mission Duration: 12 days.

Docking with the ISS occurred at 9:59 a.m. EDT April 21. The advanced robotic arm, called Canadarm2, was attached to a pallet on the outside of the U.S. Destiny Lab. It was later directed to walk off the pallet and grab onto an electrical grapple fixture on Destiny that would provide data, power and telemetry to the arm. Days later the arm was used to hand off the cradle, on which it rested inside Endeavour's payload bay during launch, to the orbiter's arm. The exchange of the cradle from the station's Mobile Servicing System (MMS) Canadarm2 to the shuttle's RMS Canadarm marked the first ever robotic-to-robotic transfer in space.

As the astronauts rewired power and data connections for the arm, the backup power circuit failed to respond to commands from station flight engineer Susan Helms, who was operating from a workstation inside Destiny. Disconnecting and reconnecting the cables at the base of the arm resolved the situation and the redundant power path to the arm was then completed.

Other crew activities during the mission included attaching a UHF antenna on the outside of the station and inside, calibrating the Space Vision System – an alignment aid for operating the robotic arm – plus helping repair the space station's treadmill and also filming for IMAX.

### **ISS Trouble in Space**

Computer problems surfaced late on April 24 when flight controllers for the station experienced a loss of command and control computer No. 1, one of three computers on board for systems management. The result was a loss of communication and data transfer between the space station Flight Control Room in Houston and the station.

Communication was routed through *Endeavour*, which enabled the station crew and flight controllers to talk to one another. No computer problems were encountered on *Endeavour*. Activities involving the Canadarm2 RMS were postponed.

Station flight engineer Susan Helms, using a laptop computer, was able to restore the ground's ability to monitor and send commands to the station's US systems. Through the laptop, data from the station computers could be transmitted to the ground for analysis and investigation of the problems.

Computer restoration continued successfully, especially C&C number three. C&C number one was found to have a failed hard drive. It was replaced by a backup payload computer.

Ground controllers successfully synchronized timers on all on-board computers and investigated an error in the software load that might have caused the computer problem. With one operational C&C computer in Destiny and a back-up laptop in Unity, the undocking procedure for Raffaello was given the go-ahead.

*Endeavour* undocked from the space station April 29, fired a separation burn and headed for home.

## **PLACE AND DATE OF BIRTH**

Born August 29, 1959, in Sarnia and raised in Milton, Ont.

## **EDUCATION**

Chris Hadfield's education includes:

- Graduate as an Ontario Scholar from Milton District High School,
- Bachelor degree in mechanical engineering (with honours) from RMC,
- Post-graduate research at the University of Waterloo, and
- Master of Science (aviation systems) from the University of Tennessee.

## **PROFESSIONAL EXPERIENCE**

In total, Chris Hadfield has flown over 70 different types of aircraft. Raised on a corn farm in southern Ontario, he became interested in flying at a young age. As an air cadet, he won a glider pilot scholarship at age 15 and a power scholarship at age 16. He also taught skiing and ski racing part- and full-time for 10 years.

Hadfield underwent basic flight training in Portage La Prairie, Man., for which he was named top pilot in 1980. In 1983, he took honours as the overall top graduate from Basic Jet Training in Moose Jaw, Sask. and, in 1984–1985, he trained as a fighter pilot in Cold Lake, Alta. on CF-5s and CF-18s. For the next three years Hadfield flew CF-18s for the North American Aerospace Defence Command (NORAD) with 425 Squadron, during which time he flew the first CF-18 intercept of a Soviet "Bear" aircraft. He attended the United States Air Force (USAF) Test Pilot School at Edwards Air Force Base, in California and, upon graduation, served as an exchange officer with the US Navy at Strike Test Directorate at the Patuxent River Naval Air Station.

Colonel Hadfield's military accomplishments from 1989 to 1992 included:

- testing the F/A-18 and A-7 aircraft;
- completing the first military flight of F/A-18 enhanced performance engines;
- developing a new handling qualities rating scale for high angle-of-attack test;
- participating in the F/A-18 out-of-control recovery test program;
- performing research with NASA on pitch control margin simulation and flight; and
- piloting the first flight test of the National Aerospace Plane external-burning hydrogen propulsion engine.

## **SPECIAL HONOURS**

Chris Hadfield's special honours include:

- recipient of Liethen-Tittle Award 1988 (top pilot graduate of the USAF Test Pilot School),
- recipient of U.S. Navy Test Pilot of the Year (1991),

- recipient of honorary Doctorate of Engineering from the Royal Military College (1996),
- recipient of Member of the Order of Ontario (1996),
- recipient of honorary Doctorate of Laws from Trent University (1999),
- recipient of Vanier Award (2001),
- recipient of Meritorious Service Cross (2001),
- recipient of NASA Exceptional Service Medal (2002),
- recipient of Queen Elizabeth II Golden Jubilee Medal (2003),
- inducted into Canada's Aviation Hall of Fame (2005), and
- commemorated on Royal Canadian Mint silver and gold coins for his spacewalk to install Canadarm2 on the ISS (2006).

### **AFFILIATIONS**

Chris Hadfield's affiliations include:

- Royal Military College Club,
- Society of Experimental Test Pilots,
- Canadian Aeronautics and Space Institute,
- Honourary Patron of Lambton College,
- Trustee of Lakefield College School,
- Board member of the International Space School Foundation, and
- Executive with the Association of Space Explorers.

THIS PAGE INTENTIONALLY LEFT BLANK

## ASTRONAUT BOB THIRSK



*Canadian Space Agency, 2008, Image Gallery: Bob Thirsk. Retrieved March 2, 2008, from [http://www.space.gc.ca/asc/app/gallery/results2.asp?session=&image\\_id=Thrisk-1001](http://www.space.gc.ca/asc/app/gallery/results2.asp?session=&image_id=Thrisk-1001)*

Figure 15E-1 Astronaut Robert (Bob) Thirsk

## **ASTRONAUT BOB THIRSK**

In June and July 1996, Thirsk flew as a payload specialist aboard space shuttle mission STS-78, the Life and Microgravity Spacelab (LMS) mission. During this 17-day flight aboard Columbia, he and his six crewmates performed 43 international experiments devoted to life science and materials science.

In 2008, Thirsk was assigned to a long-duration flight as a member of Expedition 19 on the ISS, with duties that include robotic operations and conducting scientific experiments on behalf of Canadian and international researchers.

### **MISSIONS:**

#### **STS-78**

Mission: LMS.

Space Shuttle: Columbia.

Launched: June 20, 1996, 10:49:00 a.m. EDT.

Landed: July 7, 1996, 8:36:45 a.m. EDT.

Mission Duration: 17 days.

Orbit Altitude: 150 nautical miles.

#### **Mission Highlights**

Five space agencies (NASA, European Space Agency, French Space Agency, Canadian Space Agency, and Italian Space Agency) and research scientists from 10 countries worked together on primary payload experiments of LMS. More than 40 experiments flown were grouped into two areas:

- life sciences, which included human physiology and space biology; and
- microgravity science, which included basic fluid physics investigations, advanced semiconductor and metal alloy materials processing and medical research in protein crystal growth.

Regarding STS-78, NASA observed:

Canadian Space Agency astronaut Bob Thirsk was uniquely qualified for this mission. A bio-medical engineer and a medical doctor, his knowledge and expertise reached into many areas, notably in the physiological adaptations that occur in weightlessness as well as in microgravity experimentation relating to materials processing and fluid physics.

Since 1983, when he was selected to become an astronaut, Bob Thirsk has accumulated 16 years of operational experience. He first trained as back-up Payload Specialist to Marc Garneau for Mission 41-G in October 1984. He was an investigator for three experiments that flew on previous Spacelab missions and was an alternate Payload Specialist on the IML-1 Mission.

One of the most common physiological changes astronauts must live with in a weightless environment is the redistribution of body fluids which can cause discomfort or problems in space or upon returning to earth. Thirsk was leader of an international team investigating this shift of body fluids in weightlessness and its effects on the body's venous system. He has designed an experimental antigravity suit, a pressure suit he believes will help astronauts readapt to life back on earth.

During STS-78, Bob Thirsk participated in a number of experiments in life and microgravity sciences. Like the other six astronauts, he was both subject and researcher for several life sciences investigations. He had a major role in Canada's Torso Rotation Experiment (TRE), designed by McGill University and sponsored by



the Canadian Space Agency. TRE related eye/head/body movements to the symptoms of motion sickness that many astronauts experience. Thirsk was also involved in four muscle physiology experiments. Studies on previous missions have revealed a loss of muscle mass, biochemical changes in the muscle that oppose gravity and changes in the performance of certain muscle groups that bear weight and support the skeleton.

Dr. Thirsk had a strong interest in the lung function experiment whose goal was to explain the large differences in the ventilation and the perfusion (blood flow) to the top and bottom of the lung.

Bob Thirsk also participated in one microgravity science experiment, the Protein Crystallization Facility Experiment. The astronauts crystallized large proteins (such as DNA, RNA or viruses) that were analysed back on earth. The goal was to better understand the interactions within and between proteins and, eventually, to design better drugs to inhibit or improve certain effects.

The Columbia orbiter itself played a key part in tests to support raising the Hubble Space Telescope (HST) to a higher orbit during HST's second servicing mission. Columbia's vernier Reaction Control System jets were gently pulsed to boost the orbiter's altitude without jarring payloads. Raising the orbiter Columbia very gently, provided experience used to inform orbiter *Discovery's* later mission STS-82 how to raise HST's orbit without impacting its solar arrays. During STS-82 in February 1997, orbiter *Discovery* did indeed fire its manoeuvring jets several times to successfully boost HST to an orbit eight nautical miles higher.

### **PLACE AND DATE OF BIRTH**

Born August 17, 1953, in New Westminster, B.C.

### **EDUCATION**

Robert Thirsk's education includes:

- Primary and secondary schools in B.C., Alta., and Man.,
- BSc degree in Mechanical Engineering from the University of Calgary,
- MSc in Mechanical Engineering from the Massachusetts Institute of Technology (MIT),
- Doctorate of Medicine from McGill University, and
- Master of Business Administration from the MIT Sloan School of Management.

### **PROFESSIONAL EXPERIENCE**

Robert Thirsk was in the family medicine residency program at the Queen Elizabeth Hospital in Montréal when he was selected in December 1983 for the Canadian Astronaut Program. He began astronaut training in February 1984 and served as backup payload specialist to Marc Garneau for the October 1984 space shuttle mission STS-41G.

Thirsk has been involved in various CSA projects including parabolic flight campaigns and mission planning. He served as crew commander for two space mission simulations: the seven-day CAPSULES mission in 1994, at Defence Research and Development Canada in Toronto, and the 11-day NEEMO 7 undersea mission in 2004 at the National Undersea Research Center in Key Largo, Florida. He also led an international research team investigating the effect of weightlessness on the heart and blood vessels.

In 1998, Thirsk was assigned by the CSA to NASA's Johnson Space Center in Houston to pursue mission specialist training. This training program involves advanced instruction on both shuttle and space station systems, extravehicular activity (EVA), robotic operations, and the Russian language. Within the NASA Astronaut Office, Thirsk serves as a capsule communicator (CapCom) for the International ISS program. CapComs participate in actual and simulated space missions as a communication link between the ground team at Mission Control and the astronauts in orbit. CapComs speak directly with the space station crew and assist with technical planning for the mission and last minute troubleshooting.

In 2004, Thirsk trained at the Yuri Gagarin Cosmonaut Training Centre near Moscow and became certified as a Flight Engineer for the Soyuz spacecraft. He served as backup Flight Engineer to European Space Agency (ESA) astronaut Roberto Vittori for the Soyuz 10S taxi mission to the ISS in April 2005. During the 10-day mission, Thirsk worked as Crew Interface Coordinator (European CapCom) at the Columbus Control Centre in Germany. Thirsk then returned to the Johnson Space Center in Houston to begin ISS Expedition crew training.

Further to Thirsk's CapCom training and experience for NASA missions, in 2007 he underwent Eurocom (European capsule communicator) training in Germany to support the European Space Agency's (ESA) Columbus Control Centre (COL-CC). The COL-CC provides command and control for the Columbus laboratory which was carried into orbit on February 7, 2008, by STS-122.

### **SPECIAL HONOURS**

Bob Thirsk's special honours include:

- recipient of the Association of Professional Engineers, Geologists and Geophysicists of Alberta Gold Medal,
- recipient of the University of Calgary Distinguished Alumni Award,
- recipient of the Gold Medal of the Professional Engineers of Ontario, and
- honorary membership in the College of Physicians and Surgeons of British Columbia.

### **AFFILIATIONS**

Bob Thirsk's affiliations include:

- Professional Engineers of Ontario,
- Canadian College of Family Physicians,
- Canadian Aeronautics and Space Institute,
- Aerospace Medical Association,
- Colleges of Physicians and Surgeons of Ontario and of British Columbia, and
- Canadian Foundation for the International Space University.

## ASTRONAUT BJARNI TRYGGVASON



*Canadian Space Agency, 2008, Image Gallery: Bjarni Tryggvason. Retrieved March 2, 2008, from [http://www.space.gc.ca/asc/app/gallery/results2.asp?session=&image\\_id=astronaut](http://www.space.gc.ca/asc/app/gallery/results2.asp?session=&image_id=astronaut)*

Figure 15F-1 Astronaut Bjarni Tryggvason

## **ASTRONAUT BJARNI TRYGGVASON**

Bjarni Tryggvason is an airline transport rated pilot with more than 4 500 hours of flight experience and 1 800 hours as a flight instructor. He is active in aerobatic flight including time on the Tutor jet trainer with the Canadian Forces. He enjoys jogging, skiing and general fitness. He has two children.

## **MISSIONS**

### **STS-85**

Mission: Cryogenic Infrared Spectrometers and Telescopes for the Atmosphere-Shuttle Pallet Satellite-2 (CRISTA-SPAS-02).

Space Shuttle: *Discovery*.

Launched: August 7, 1997, 10:41:00 a.m. EDT.

Landed: August 19, 1997, 7:07:59 a.m. EDT.

Mission Duration: 12 days.

Orbit Altitude: 150 nautical miles.

STS-85 carried a complement of payloads in the cargo bay that focused on Mission to Planet Earth objectives as well as preparations for ISS assembly:

- the Japanese Manipulator Flight Development (MFD),
- the Technology Applications and Science-01 (TAS-1),
- the International Extreme Ultraviolet Hitchhiker-02 (IEH-02), and
- CRISTA-SPAS-02.

This was the second flight of CRISTA-SPAS payload. CRISTA-SPAS-02 represented the fourth mission in a cooperative venture between the German Space Agency (DARA) and NASA. The payload included three telescopes and four spectrometers, deployed on flight day one, to gather data about earth's middle atmosphere. After more than 200 hours of free flight, CRISTA-SPAS-02 was retrieved on August 16. The three CRISTA telescopes collected 38 full atmospheric profiles of the middle atmosphere. A total of 22 sounding rockets and 40 balloons were launched to provide correlating data.

A complementary instrument, the Middle Atmosphere High Resolution Spectrograph Investigation (MAHRSI), provided additional data. This new information from STS-85 combined with that from the first CRISTA-SPAS flight (STS-66 in 1994) was used to yield new insight into the distribution of ozone in earth's atmosphere. Once science operations were complete, CRISTA-SPAS was used in a simulation exercise to prepare for the first ISS assembly flight, STS-88.

TAS-1 was a Hitchhiker payload carrying eight experiments designed to demonstrate faster, better and cheaper avionics and processes. All these experiments were completed successfully:

- Solar Constant Experiment (SOLCON),
- Infrared Spectral Imaging Radiometer (ISIR),
- Shuttle Laster Altimeter (SLA),
- Critical Viscosity of Xenon (CVX),
- Space Experiment Module (SEM),

- Two Phase Flow (TPF),
- Cryogenic Flight Experiment (CFE), and
- Stand Alone Acceleration Measurement Device and the Wide Band Stand Alone Acceleration Measurement Device (SAAMD/WBSAAMD).

MFD was designed to evaluate use of the Small Fine Arm that will be part of the future Japanese Experiment Module's Remote Manipulator System on ISS. Despite some glitches, MFD completed a series of exercises by the crew on orbit as well as operators on ground. Two unrelated Japanese experiments, Two-Phase Fluid Loop Experiment (TPFLEX) and Evaluation of Space Environment and Effects on Materials (ESEM), were mounted near the Small Fine Arm in the payload bay.

IEH-02 was flying a second time and consisted of four experiments—all with the common objective of investigating solar extreme ultraviolet (EUV) flux and EUV emissions of the Jupiter/Io plasma torus system:

- Solar Extreme Ultraviolet Hitchhiker-2 (SEH),
- Ultraviolet Spectrography Telescope for Astronomical Research (UVSTAR),
- Distribution and Automation Technology Advancement - Colorado Hitchhiker and Student Experiment of Solar Radiation (DATA-CHASER), and
- Shuttle Glow Experiment-5 and -6.

Payloads inside the cabin included:

- Protein Crystal Growth - Single locker Thermal Enclosure System (PCG-STES),
- Midcourse Space Experiment (MSX),
- Shuttle Ionospheric Modification with Pulsed Local Exhaust (SIMPLEX),
- Southwest Ultraviolet Imaging System (SWUIS), used to observe the Hale-Bopp comet,
- two Get Away Special (GAS) payloads,
- Biological Research in Canisters-10 (BRIC-10), one in a series of flights,
- Solid Surface Combustion Experiment (SSCE), and
- Bioreactor Demonstration System-3 (BDS-3), a cell-biology research payload that had flown previously. On this flight, BDS was used for growing colon cancer cells to a larger size than can be achieved on earth.

The crew also worked with the Orbiter Space Vision System (OSVS), which will be used during ISS assembly. OSVS features series of dots, strategically placed on various payload and vehicle structures, which permit precise alignment and pointing capability.

### **PLACE AND DATE OF BIRTH**

Born September 21, 1945, in Reykjavik, Iceland.

### **EDUCATION**

Bjarni Tryggvason's education includes:

- Primary school in N.S. and B.C.,
- High school in Richmond, B.C.,

- BAsC in Engineering Physics from the University of British Columbia, and
- completed postgraduate work in engineering with specialization in applied mathematics and fluid dynamics at the University of Western Ontario.

## PROFESSIONAL EXPERIENCE

Bjarni Tryggvason was a meteorologist with the cloud physics group at the Meteorologic Service Canada (formerly the Atmospheric Environment Service) in Toronto in 1972 and 1973. After that, he served as a research associate in industrial aerodynamics at the Boundary Layer Wind Tunnel Laboratory at the University of Western Ontario from 1974 to 1979.

Tryggvason was a guest research associate at Kyoto University, in Kyoto, Japan, in 1979 and at James Cook University of North Queensland, in Townsville, Australia in 1980. He was a lecturer in Applied Mathematics at the University of Western Ontario from 1980 to 1982.

From 1982 to 1984, Tryggvason was a research officer at the Low Speed Aerodynamics Laboratory at the National Research Council of Canada (NRC) and was a lecturer at the University of Ottawa and at Carleton University from 1982 to 1992.

Selected as one of the original six Canadian astronauts in December 1983, Tryggvason trained as a backup payload specialist for the CANEX-2 set of experiments, which flew on Mission STS-52 in October 1992. He was also the project engineer for the Space Vision System Target Spacecraft, which was deployed during that mission.

Tryggvason also served as the principal investigator for the following projects:

- development of the Large Motion Isolation Mount (LMIM), which flew numerous times on NASA KC-135 and DC-9 aircraft,
- Microgravity vibration Isolation Mount (MIM), which operated on the Russian space station, Mir, from April 1996 until January 1998 to support several Canadian and US experiments in material science and fluid physics, and
- the MIM-2 which flew on STS-85 in August 1997.

He was the originator and technical director during the early development phase of the Microgravity Vibration Isolation Subsystem (MVIS), which the CSA developed for the European Space Agency Fluid Science Laboratory for the ISS.

On August 7, 1997, Tryggvason flew as a payload specialist aboard Space Shuttle *Discovery* on Mission STS-85. His primary role was to test MIM-2 and perform fluid science experiments designed to examine sensitivity to spacecraft vibrations, in order to develop a better understanding of the need for systems such as the MIM on the ISS and to study the effect vibrations have on the many experiments performed on the ISS.

In August 1998, Tryggvason was invited to take part in NASA mission specialist training held at the Johnson Space Center in Houston, Texas. His class underwent two years of physical and academic training and was the first group of astronauts to be trained as both mission specialists for the space shuttle and as potential crewmembers for the ISS.

Following completion of mission specialist training, Tryggvason's NASA duties included serving as a crew representative for the Shuttle Avionics Integration Laboratory (SAIL), which is used to test shuttle flight software prior to onboard use. He also supported integrated simulations on the ISS Training Facility at the Johnson Space Center in Houston, Texas, and served as a CSA representative on the NASA Microgravity Measurement Working Group and on the ISS Microgravity Analytic Integration Team.

From mid 2001 to 2003, Tryggvason worked in the private sector while on leave from the CSA. He returned to work at the CSA in 2004. He has held the position of visiting professor at the University of Western Ontario. He has written more than 50 published papers and holds three patents.

### **SPECIAL HONOURS**

Bjarni Tryggvason's special honours include:

- recipient of the Canadian Space Agency Innovators Award,
- recipient of the Order of the Falcon from Iceland,
- recipient of the NASA Space Flight Medal, and
- recipient of the Doctorate of Philosophy (honoris causa) degrees, from:
  - University of Iceland, and
  - University of Western Ontario.

### **AFFILIATIONS**

Bjarni Tryggvason's affiliations include the Canadian Aeronautics and Space Institute.

THIS PAGE INTENTIONALLY LEFT BLANK



## ASTRONAUT DAVE WILLIAMS



*Canadian Space Agency, 2008, Image Gallery: Dave Williams. Retrieved March 2, 2008, from <http://spaceflight.nasa.gov/gallery/images/shuttle/sts-118/html/jsc2001-00190.html>*

Figure 15G-1 Astronaut Dave Williams

## **ASTRONAUT DAVE WILLIAMS**

Dave Williams is married and has two children. He enjoys flying, scuba diving, hiking, sailing, kayaking, canoeing, downhill and cross-country skiing.

### **MISSIONS**

#### **STS-90**

Mission: Neurolab (the final Spacelab mission).

Space Shuttle: Columbia.

Launched: April 17, 1998, 2:19:00 p.m. EDT.

Landed: May 3, 1998, 12:08:59 p.m. EDT.

Mission Duration: 16 days.

Orbit Altitude: 150 nautical miles.

The launch of Columbia was postponed on April 16 for 24 hours due to difficulty with one of Columbia's two network signal processors, which format data and voice communications between the ground and the space shuttle. The network signal processor 2 was replaced, and Columbia lifted off on April 17.

#### **Mission Highlights**

Neurolab's 26 experiments targeted one of the most complex and least understood parts of the human body – the nervous system. The primary goals were to conduct basic research in neurosciences and expand understanding of how the nervous system develops and functions in space. Test subjects were crew members, rats, mice, crickets, snails and two kinds of fish. This was a cooperative effort of the Canadian Space Agency and several other national space agencies, including ESA (European Space Agency), NASA (USA), CNES (France), DARA (Germany) and NASDA (Japan). Most experiments were conducted in the pressurized Spacelab long module located in Columbia's X bay. This was the 16<sup>th</sup> and last scheduled flight of the ESA-developed Spacelab module although the Spacelab pallets continued to be used on the ISS.

#### **STS-118**

Launch: Aug. 8, 2007, 6:36 p.m. EDT.

Landed: Aug. 21, 2007, 12:33 p.m. EDT.

Orbiter: *Endeavour*.

Mission Number: STS-118.

Mission Duration: 12 days, 17 hours, 55 minutes.

Altitude: 122 nautical miles.

Primary Payload: 22<sup>nd</sup> station flight (13A.1), S5 Truss.

Dave Williams was a mission specialist on [STS-118](#), the 22<sup>nd</sup> flight to the ISS and the 20<sup>th</sup> flight for *Endeavour*. During the mission, the crew successfully added truss segment S5, a new gyroscope and an external stowage platform to the ISS.



Show the cadets Figure 15G-2.

The mission successfully activated a new system that enables docked shuttles to draw electrical power from the ISS to extend visits to the outpost. Williams took part in three of the four spacewalks – the highest number of spacewalks performed in a single mission. He spent 17 hours and 47 minutes outside – a Canadian record. *Endeavour* carried 2 280 kg of equipment and supplies to the station and returned to earth with 1 800 kilograms of hardware and used equipment. Travelling 8.5 million km in space, the STS-118 mission was completed in 12 days, 17 hours, 55 minutes, and 34 seconds.

### **PLACE AND DATE OF BIRTH**

Born May 16, 1954, in Saskatoon, Sask.

### **EDUCATION**

Dave Williams' education includes:

- High school in Beaconsfield, Que.,
- BSc (Biology) from McGill University,
- MSc (Physiology) from McGill University,
- Doctorate of Medicine from the Faculty of Medicine, McGill University,
- Master of Surgery from the Faculty of Medicine, McGill University, and
- Completed a residency in family practice in the Faculty of Medicine, University of Ottawa.

### **PROFESSIONAL EXPERIENCE**

Dave Williams pursued postgraduate studies in advanced invertebrate physiology at the Friday Harbour Laboratories at the University of Washington, Seattle, but his interests shifted to vertebrate neurophysiology when, for his master's thesis, he became involved in basic science research on how adrenal steroid hormones modify the regulation of sleep-wake cycles. While working in the Neurophysiological Laboratories at the Allan Memorial Institute for Psychiatry, Williams assisted in clinical studies of slow wave potentials within the central nervous system.

Williams served as an emergency physician with the Emergency Associates of Kitchener-Waterloo and as the medical director of the Westmount Urgent Care Clinic. Subsequently, he became the director of the Department of Emergency Services at Sunnybrook Health Science Centre and assistant professor of Surgery at the University of Toronto.

In June 1992, the CSA selected Williams as one of four successful candidates from a field of 5 330 applicants to begin astronaut training. He completed basic training and, in May 1993, was appointed manager of the Missions and Space Medicine Group within the Canadian Astronaut Program. His assignments included supervising the implementation of operational space medicine activities for the Canadian Astronaut Program Space Unit Life Simulation (CAPSULS) Project.

In January 1995, Williams was selected to join the international class of NASA mission specialist astronaut candidates. He reported to the Johnson Space Center (JSC) in March 1995, for a year of training and evaluation. Following the successful completion of this training in May 1996, he was assigned to the Payloads and Habitability Branch of the NASA Astronaut Office.

From July 1998, until September 2002, Dave Williams held the position of Director of the Space and Life Sciences Directorate at the Johnson Space Center in Houston, Texas. With this appointment, he became the first non-American to hold a senior management position within NASA. He concurrently held a six-month position as the first deputy associated administrator for crew health and safety in the Office of Space Flight at NASA Headquarters in 2001.

In addition to these assignments, Dave Williams continued to take part in astronaut training to maintain and further develop his skills. In October 2001, he became an aquanaut through his participation in the joint NASA-NOAA (National Oceanic and Atmospheric Administration) NEEMO 1 mission, a training exercise held in Aquarius, the world's only underwater research laboratory located 5.6 km off the shores of Key Largo, Florida. During this seven-day exercise, Williams became the first Canadian to have lived and worked in space and in the ocean.

In 2006, Dave Williams took the lead of [NEEMO 9](#) as the crew commander of this mission, dedicated to assess new ways to deliver medical care to a remote location, as in a long space flight.

## **SPECIAL HONOURS**

Dave Williams' special honours include:

- Academic awards:
  - recipient of the A.S. Hill Bursary, McGill University (1980),
  - recipient of the Walter Hoare Bursary, McGill University (1981),
  - recipient of the J.W. McConnell Award, McGill University (1981 to 1983),
  - Faculty Scholar (1982), Faculty of Medicine, McGill University,
  - University Scholar (1983), Faculty of Medicine, McGill University,
  - recipient of the Psychiatry Prize, Wood Gold Medal,
  - Dean's Honour List, Physiology Department, McGill University (1983), and
  - recipient of Second prize (1986, 1987, 1988) for participation in the University of Toronto Emergency Medicine Research Papers Program;
- recipient of the Commonwealth Certificate of Thanks and the Commonwealth Recognition Award for contributions to the Royal Life Saving Society of Canada,
- recipient of the NASA Space Flight Medal,
- recipient of the Melbourne W. Boynton Award, American Astronautical Society (1999),
- recipient of the Ramon y Cajal Institute of Neurobiology, Spanish Council for Scientific Research (CSIC) Bronze Medal for contribution to neuroscience during Mission STS-90 (1999),
- recipient of the Rotary National Award for Space Achievement (2000),
- recipient of the NASA Outstanding Leadership Medal (2002),
- Patron of the International Life Saving Federation (2002),
- Spokesperson for the Life Saving Society Canada,
- Honorary Ambassador of the SmartRisk Foundation,

- NASA JSC Space and Life Sciences Directorate Special Professional Achievement Award (2003) for the implementation of the Automatic External Defibrillator Program that has saved several lives at the NASA Johnson Space Center, and
- Honorary Doctor of Laws, University of Saskatchewan (2004).

## **AFFILIATIONS**

Dave Williams' affiliations include:

- Member of the College of Physicians of Ontario,
- Member of Ontario Medical Association,
- Member of the Canadian Association of Emergency Physicians,
- Member of the Undersea and Hyperbaric Medicine Society, and
- Member of the Aerospace Medical Association.

Past affiliations include:

- Society for Neuroscience,
- New York Academy of Science, and
- Montreal Physiological Society.

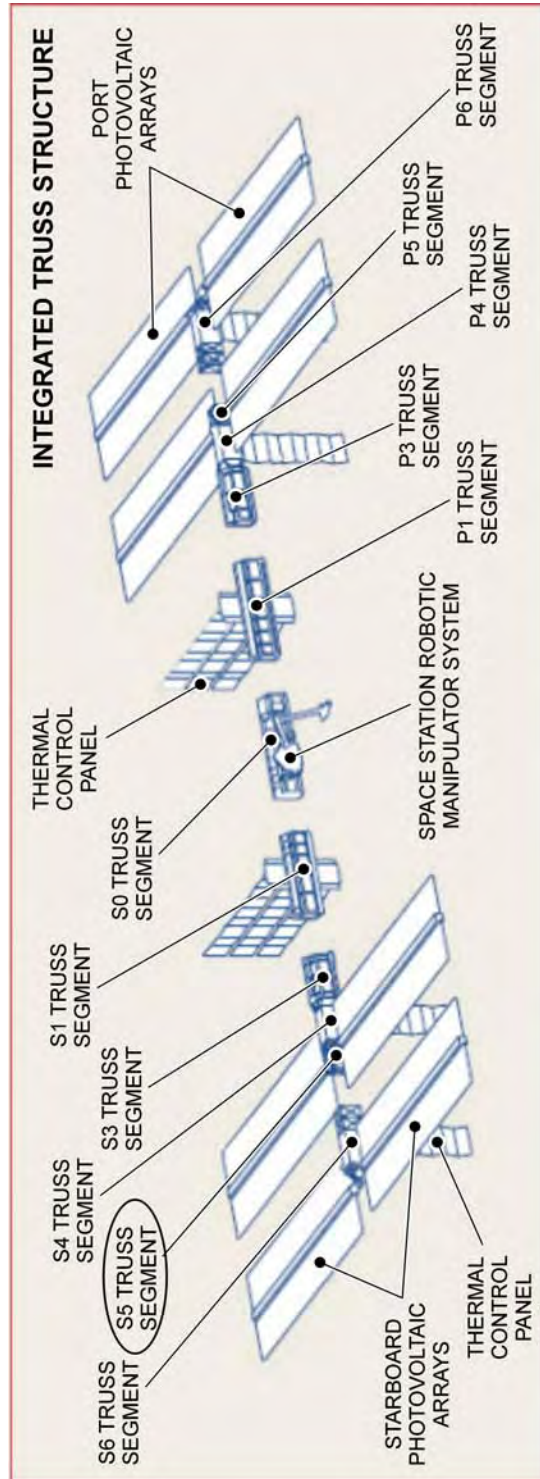

Canadian Space Agency, 2007, *Missions: STS-118 Mission Overview*. Retrieved March 2, 2008, from <http://www.space.gc.ca/asc/eng/missions/sts-118/overview.asp>

Figure 15G-2 Integrated Truss S5

**ASTRONAUT JULIE PAYETTE**



*Canadian Space Agency, 2008, Astronauts: Julie Payette Biography. Retrieved March 2, 2008, from <http://www.space.gc.ca/asc/eng/astronauts/biopayette.asp>*

Figure 15H-1 Astronaut Julie Payette

## **ASTRONAUT JULIE PAYETTE**

Julie Payette enjoys running, skiing, racquet sports and scuba diving. She has a commercial pilot licence with float rating. Fluent in French and English, she can converse in Spanish, Italian, Russian and German. She plays the piano and has sung with the Orchestre symphonique de Montréal, the Piacere Vocale in Basel, Switzerland and the Tafelmusik Baroque Orchestra in Toronto. She is married and has two children.

### **MISSIONS**

#### **STS-96**

Mission: Second International Space Station Flight.

Space Shuttle: [Discovery](#).

Launched: May 27, 1999, 6:49:42 a.m. EDT.

Landed: June 6, 1999, 2:02:43 a.m. EDT.

Mission Duration: 10 days.

Orbit Altitude: 173 nautical miles.

#### **Mission Highlights**

All major objectives were accomplished during the mission. On May 29<sup>th</sup>, *Discovery* made the first docking to the ISS as it flew over the Russian-Kazakh border.

The 45<sup>th</sup> space walk in space shuttle history and the fourth of the ISS era took place during this mission. Astronauts transferred a US-built crane called the orbital transfer device and parts of the Russian crane Strela from the shuttle's payload bay and attached them to locations on the outside of the station. The astronauts also installed two new portable foot restraints, which will fit both American and Russian space boots, and they attached three bags filled with tools and handrails for use during future assembly operations.

The crew transferred 3 567 pounds of material, including clothing, sleeping bags, spare parts, medical equipment, supplies, hardware and about 84 gallons of water, to the interior of the station. The astronauts also installed parts of a wireless strain gauge system to help engineers track the effects of adding modules to the station throughout its assembly.

The astronauts spent a total of 79 hours, 30 minutes inside the station. Before departure, a series of 17 pulses of *Discovery*'s reaction control system jets boosted the station to an orbit of approximately 246 statute miles. After spending 5 days, 18 hours and 17 minutes linked to the station, *Discovery* undocked at 6:39 p.m. EDT. *Discovery*'s jets fired to move to a distance of about 400 feet for a 2-1/2 lap fly-around during which the crew made a detailed photographic record of the ISS.

After the fly-around, mission specialist Julie Payette deployed the Starshine satellite from the orbiter's cargo bay. The spherical, reflective object entered an orbit two miles below *Discovery*. The small probe became instantly visible from Earth as part of a project allowing more than 25 000 students from 18 countries to track its progress. Other payloads included the Shuttle Vibration Forces experiment and the Integrated Vehicle Health Monitoring for the Human Exploration and Development of Space (HEDS) Technology Demonstration.

### **PLACE AND DATE OF BIRTH**

Born October 20, 1963, in Montréal, Que.

### **EDUCATION**

Julie Payette's education includes:



- primary and secondary school in Montréal, Que.,
- International Baccalaureate from United World College of the Atlantic in Wales, UK,
- Bachelor of Engineering, Electrical cum laude from McGill University, Montréal, and
- Master of Applied Science, Computer Engineering, from the University of Toronto.

## **PROFESSIONAL EXPERIENCE**

Before joining the space program, Julie Payette conducted research in computer systems, natural language processing and automatic speech recognition.

Her previous employment included:

- system engineer with IBM Canada (1986–1988),
- research assistant at the University of Toronto (1988–1990),
- visiting scientist at the IBM Research Laboratory, in Zurich, Switzerland (1991),
- research engineer with BNR/Northern in Montréal (1992), and
- in June 1992, the Canadian Space Agency selected Ms. Payette from 5 330 applicants to become one of four astronauts.

After her basic training in Canada, she worked as a technical advisor for the Mobile Servicing System (MSS Canadarm2), an advanced robotics system contributed by Canada to the ISS. In preparation for a space mission assignment, Payette obtained her commercial pilot license, studied Russian and logged 120 hours as a research operator on board reduced gravity aircraft. In April 1996, Payette was certified as a one-atmosphere, deep-sea diving suit operator. Payette obtained her military pilot captaincy on the CT-114 Tutor jet at the Canadian Forces Base in Moose Jaw, Sask. in February 1996. She obtained her military instrument rating in 1997. She has logged more than 1 200 hours of flight time.

Payette reported to the NASA Johnson Space Center in Houston, Texas in August 1996. She completed initial astronaut training in April 1998 and was assigned to work on technical issues in robotics for the Astronaut Office. In the spring of 1999, she visited the ISS aboard STS-96.

From September 1999, to December 2002, Payette was assigned to represent the astronaut corps at the European and Russian space agencies where she supervised procedure development, equipment verification and space hardware processing for the ISS Program.

After January 2003, Payette worked as a CapCom (Spacecraft Communicator) at Mission Control Center in Houston and was Lead CapCom for Space Shuttle mission STS-121 in 2006. The CapCom is responsible for all communications between ground controllers and the astronauts in flight.

## **SPECIAL HONOURS**

Julie Payette's special honours include:

- recipient of a scholarship to attend the Atlantic College in Wales, UK,
- recipient of a Greville-Smith Scholarship (highest undergraduate award at McGill University),
- McGill University Faculty Scholar (1983–1986),
- recipient of a Natural Sciences and Engineering Research Council of Canada (NSERC) Scholarship,
- recipient of a Massey College Fellowship,

- recipient of the Canadian Council of Professional Engineers Exceptional Achievement Award,
- recipient of the Chevalier de l'Ordre de la Pléiade de la francophonie,
- Ordre national du Québec,
- recipient of honorary Degrees from:
  - Queen's University,
  - University of Ottawa,
  - Simon Fraser University,
  - Université Laval,
  - University of Regina,
  - Royal Roads University,
  - University of Toronto,
  - University of Victoria,
  - Nipissing University,
  - McGill University,
  - Mount Saint Vincent University,
  - McMaster University,
  - University of Lethbridge,
  - Mount Allison University, and
  - University of Alberta.

## **AFFILIATIONS**

Julie Payette's affiliations include:

- Member of l'Ordre des Ingénieurs du Québec,
- Fellow of the Canadian Academy of Engineering,
- Queen's University Board of Directors,
- Former Governor-in-Council for NSERC, and
- Les Amies d'affaires du Ritz.

## EARLY MANNED SPACE EXPLORATION TIMELINE

### MERCURY PROGRAM

- October 1, 1958 National Aeronautics and Space Administration (NASA) created
- November 26, 1958 Mercury program announced
- December 4, 1959 Launch of Sam (a monkey) on Little Joe 2
- April 9, 1959 NASA names the seven Mercury astronauts
- January 21, 1960 Launch of Miss Sam (a monkey) on Little Joe IB
- January 31, 1961 Launch of Ham (a chimpanzee) on Mercury Redstone 2
- **May 5, 1961 Launch of Alan Shepard in Freedom 7 (suborbital)**
- July 21, 1961 Launch of Gus Grissom in Liberty 7 (suborbital)
- November 29, 1961 Launch of Enos (a chimpanzee) on Mercury Atlas 5 (orbital)
- January 3, 1962 Gemini program formally conceived
- **February 20, 1962 Launch of John Glenn in Friendship 7, first American human orbital flight**
- May 24, 1962 Launch of Scott Carpenter in Aurora 7
- October 3, 1962 Launch of Walter Schirra in Sigma 7
- May 15, 1963 Launch of Gordon Cooper in Faith 7, the final Mercury mission

### GEMINI PROGRAM

- March 23, 1965. [Gemini III](#). First manned Gemini flight completed three orbits
- June 03–07, 1965. [Gemini IV](#). First American Extra Vehicular Activity (EVA)
- August 21–29, 1965. [Gemini V](#). First use of fuel cells for electrical power
- **December 04, 1965. [Gemini VII](#). First rendezvous in space, with Gemini VI-A**
- December 15, 1965. [Gemini VI-A](#). First rendezvous in space, with Gemini VII
- **March 16, 1966. [Gemini VIII](#). First docking with another (unmanned) spacecraft**
- June 03–06, 1966. [Gemini IX-A](#). Three rendezvous and two hours of EVA
- July 18–21, 1966. [Gemini X](#). Rendezvoused with target vehicle and EVA
- September 12, 1966. [Gemini XI](#). Gemini record altitude of 1 189.3 km
- November 11, 1966. [Gemini XII](#). Final Gemini flight: rendezvous, docking, EVA

### APOLLO PROGRAM

- October, 1968 Apollo 7. Earth orbit
- **December, 1968 Apollo 8. Ten lunar orbits**
- March, 1969 Apollo 9. First manned flight of lunar module
- May, 1969 Apollo 10. Dress rehearsal for Moon landing

- **July 20, 1969 Apollo 11. First lunar landing mission (on the Sea of Tranquility)**
- November, 1969 Apollo 12. Second lunar landing (on the Ocean of Storms)
- April, 1970 Apollo 13. Mission aborted after an on-board explosion
- January, 1971 Apollo 14. Third lunar landing (at Fra Mauro)
- July, 1971 Apollo 15. Fourth lunar landing (in the Hadley Apennine region)
- April, 1972 Apollo 16. Fifth lunar landing (on the Descartes highlands)
- December, 1972 Apollo 17. Last lunar landing (on the Taurus Littrow highlands)



*NASA 40<sup>th</sup> Anniversary of the Mercury 7, by T. Gray, 2001. Retrieved March 5, 2008, from <http://history.nasa.gov/40<sup>th</sup>merc7/shepard.htm>*

Figure 15I-1 Alan B. Shepard

THIS PAGE INTENTIONALLY LEFT BLANK

**GEMINI PROGRAM**



*"Friendship 7: Biographies", by C. Gainor, 2007, James A. Chamberlin. Retrieved December 1, 2007, from <http://history.nasa.gov/friendship7/pages/bios.html>*

Figure 15J-1 James A. Chamberlin

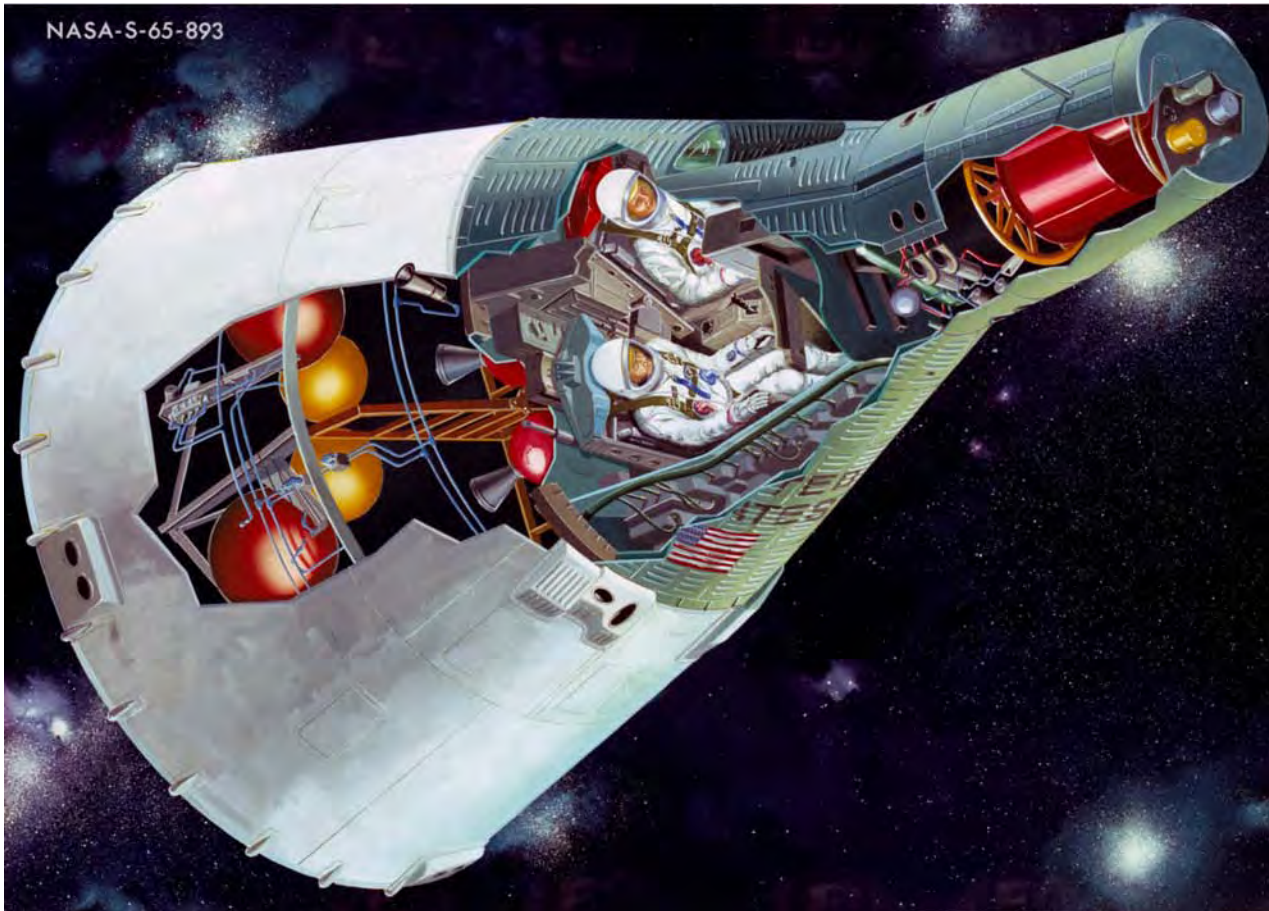

*NASA Gemini: Stepping Stone to the Moon--40 Years Later. Retrieved March 5, 2008, from [http://www.nasa.gov/mission\\_pages/gemini/index.html](http://www.nasa.gov/mission_pages/gemini/index.html)*

Figure 15J-2 Gemini Capsule Cutaway





*NASA Gemini: Stepping Stone to the Moon--40 Years Later. Retrieved March 5, 2008, from [http://www.nasa.gov/mission\\_pages/gemini/index.html](http://www.nasa.gov/mission_pages/gemini/index.html)*

Figure 15J-3 Gemini VII Seen From Gemini VI-A

THIS PAGE INTENTIONALLY LEFT BLANK

## APOLLO PROGRAM



*"Great Images in NASA", 2002, GPN-2000-000629. Retrieved December 1, 2007, from <http://grin.hq.nasa.gov/ABSTRACTS/GPN-2000-001053.html>*

Figure 15K-1 Launching Apollo 11

**APOLLO LAUNCH CONFIGURATION FOR  
LUNAR LANDING MISSION**

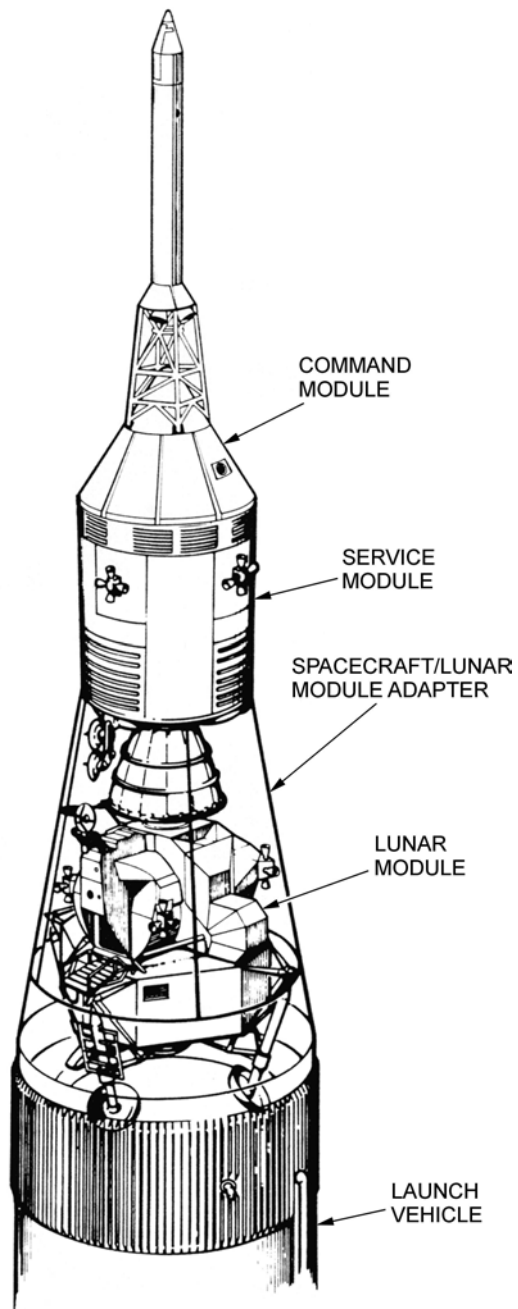

*Project Apollo Drawings and Technical Diagrams, NASA History Division, 2007. Retrieved March 5, 2008, from <http://www.hq.nasa.gov/office/pao/History/diagrams/apollo.html>*

Figure 15K-2 In the Nose Cone

**APOLLO COMMAND AND SERVICE MODULES  
 AND LAUNCH ESCAPE SYSTEM**

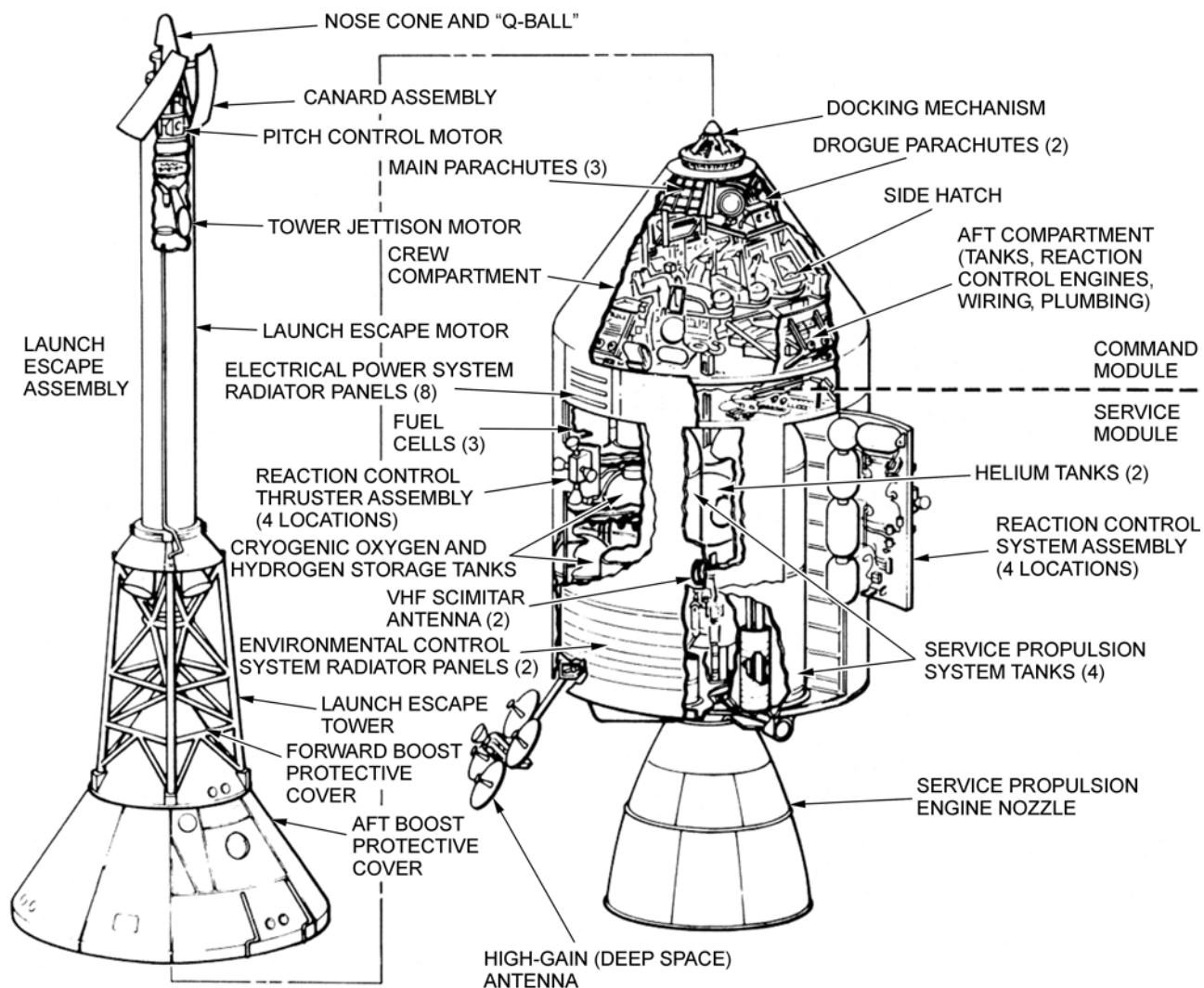

*Project Apollo Drawings and Technical Diagrams, NASA History Division, 2007. Retrieved March 5, 2008, from <http://www.hq.nasa.gov/office/pao/History/diagrams/apollo.html>*

Figure 15K-3 Modules Revealed

THIS PAGE INTENTIONALLY LEFT BLANK

### VOSTOK PROGRAM

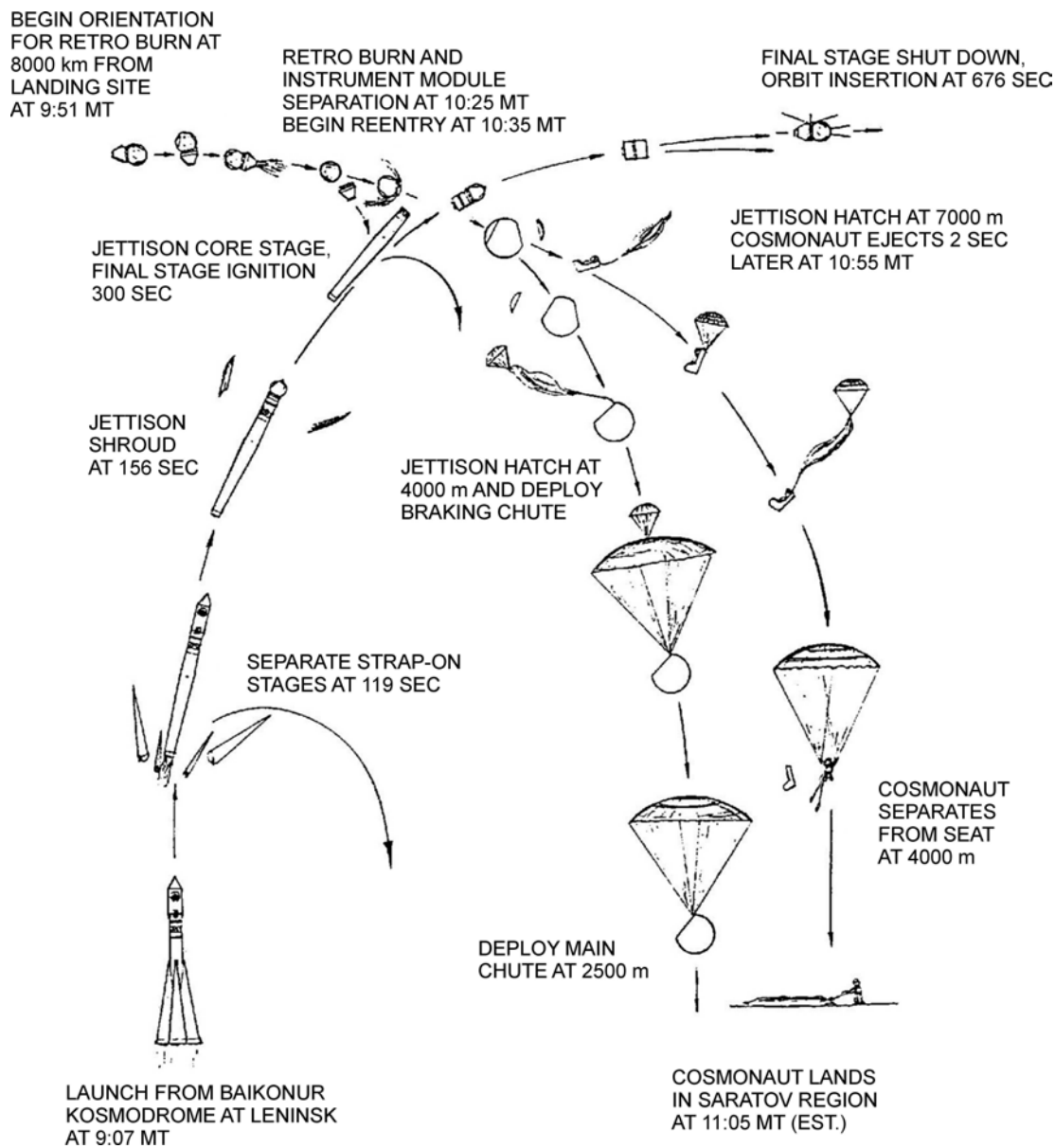

"Great Images in NASA", 2002, GPN-2002-000224. Retrieved December 1, 2007, from <http://grin.hq.nasa.gov/ABSTRACTS/GPN-2000-001053.html>

Figure 15L-1 Vostok-1 Historic First Manned Spaceflight

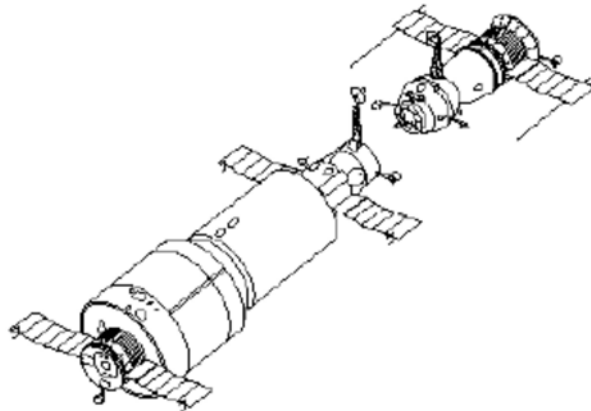

*"NASA Facts", 1997, International Space Station: Russian Space Stations. Retrieved December 1, 2007, from <http://spaceflight.nasa.gov/history/shuttle-mir/spacecraft/to-s-mir.htm>*

Figure 15L-2 Salyut-1 Station With a Soyuz About to Dock

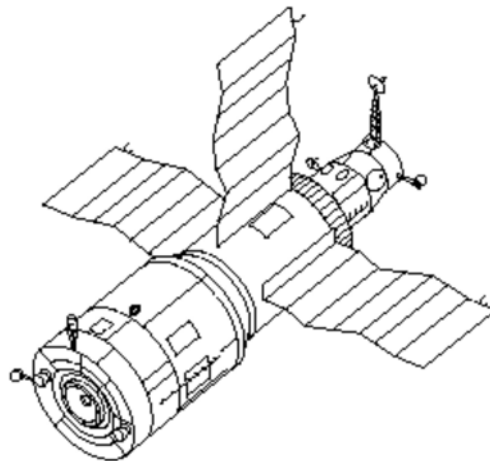

*"NASA Facts", 1997, International Space Station: Russian Space Stations. Retrieved December 1, 2007, from <http://spaceflight.nasa.gov/history/shuttle-mir/spacecraft/to-s-mir.htm>*

Figure 15L-3 Salyut-6 (1977–1982)





*"Wikipedia", 2007, Salyut Program. Retrieved November 30, 2007,  
from [http://en.wikipedia.org/wiki/Image:Salyut\\_7\\_from\\_Soyuz\\_T-13.jpg](http://en.wikipedia.org/wiki/Image:Salyut_7_from_Soyuz_T-13.jpg)*

Figure 15L-4 Salyut-7

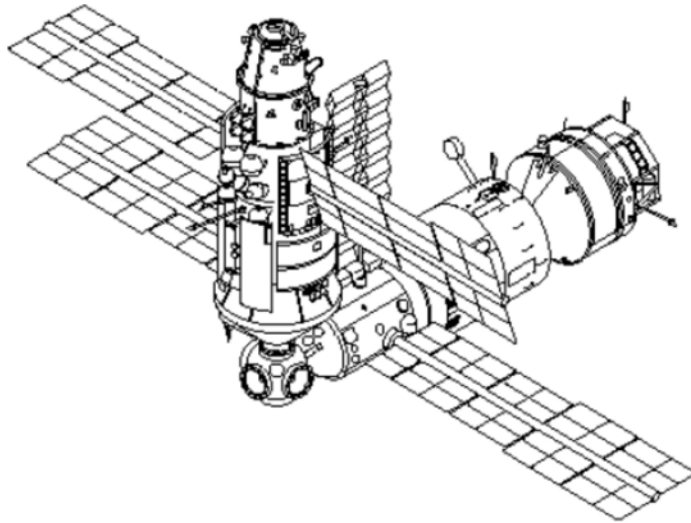

*"NASA Facts", 1997, International Space Station: Russian Space Stations. Retrieved December 1, 2007, from <http://spaceflight.nasa.gov/history/shuttle-mir/spacecraft/to-s-mir.htm>*

Figure 15L-5 Mir Space Station



*NASA "Multimedia Photo Gallery", 1998, STS 89. Retrieved December 2, 2007, from <http://spaceflight.nasa.gov/history/shuttle-mir/spacecraft/s-mir.htm>*

Figure 15L-6 The Mir Space Station and Earth

**CSA LOGO**



*Canadian Space Agency, 2008, Canadian Space Agency Logo. Retrieved April 14, 2008, from [http://upload.wikimedia.org/wikipedia/en/0/01/Canadian\\_Space\\_Agency\\_logo.png](http://upload.wikimedia.org/wikipedia/en/0/01/Canadian_Space_Agency_logo.png)*

Figure 15M-1 CSA Logo

THIS PAGE INTENTIONALLY LEFT BLANK

OSM LOGO



*Canadian Space Agency, 2008, Operational Space Medicine Logo. Retrieved April 14, 2008, from [http://www.space.gc.ca/asc/eng/astronauts/osm\\_crest.asp](http://www.space.gc.ca/asc/eng/astronauts/osm_crest.asp)*

Figure 15N-1 OSM Logo

THIS PAGE INTENTIONALLY LEFT BLANK

## CANADIAN SPACE PROGRAM

### CANADA'S INVOLVEMENT IN SPACE TECHNOLOGIES

The CSA headquarters is located at the John H. Chapman Space Centre in Saint-Hubert, Que. Canada is involved in many aspects of space exploration. Canadian scientists and researchers are particularly interested with the development and testing of space technologies.

**The David Florida Laboratory (DFL).** The David Florida Laboratory is Canada's world-class spacecraft assembly, integration and testing centre.

**The Canadian Analogue Research Network (CARN).** CARN is the organization that uses Canadian sites for field studies. These analogue sites approximate conditions that may exist or have existed on Mars and other planetary bodies such as the moon and the Solar System's icy moons.

**Partnerships With the Canadian Space Agency (CSA).** The CSA has many partners including international space agencies, industry, post-secondary researchers and educational projects.

### CSA MISSIONS

CSA has participated in many space missions with its partners. Canadian astronauts or Canadian technology has gone into space with agencies from the United States, Russia, Europe and Japan. There have been four basic types of CSA missions:

**Telecommunications.** Being able to keep all places in the country connected with advanced telecommunication services assists every Canadian in competing in the global marketplace.

**Earth Observation.** Canada's earth-observation initiatives enhance our understanding of the planet and its environment. By observing the earth from space, essential information on oceans, ice, land environments and the atmosphere is gathered.

**Space Exploration.** Canadian astronauts have been on many missions in various space shuttles. Canada is renowned for the exceptional instruments in its science satellites which collect data that will expand our understanding of the origin, formation, structure and evolution of celestial bodies and the universe.

**Space Medicine.** Space medicine combines many medical specialties to examine the effects of spaceflight on humans and prevent problems associated with living in a unique, isolated, and extreme environment like space.

For more information about the Canadian space program visit [www.space.gc.ca](http://www.space.gc.ca).

THIS PAGE INTENTIONALLY LEFT BLANK



## SPACE FLIGHT HISTORY



*"A Beginner's Guide to Rockets", Rocket Gallery. Retrieved March 24, 2007, from <http://exploration.grc.nasa.gov/education/rocket/gallery.html>*

Figure 15P-1 Dr. Robert Goddard, Father of Modern Rocketry

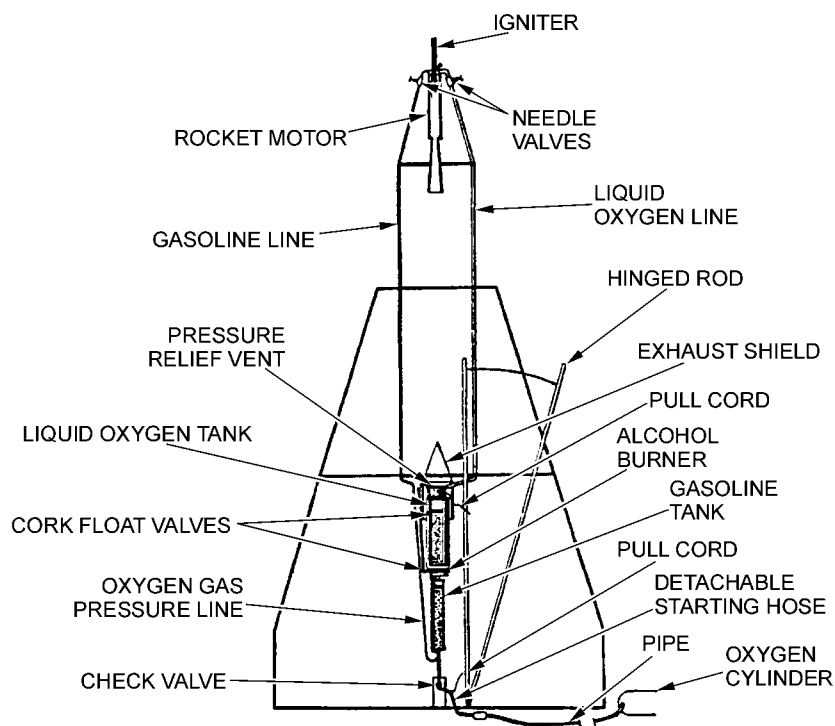

*"Rockets", A Brief History of Rockets. Retrieved March 24, 2007, from [http://www.grc.nasa.gov/WWW/K-12/TRC/Rockets/history\\_of\\_rockets.html](http://www.grc.nasa.gov/WWW/K-12/TRC/Rockets/history_of_rockets.html)*

Figure 15P-2 Goddard's 1926 Rocket

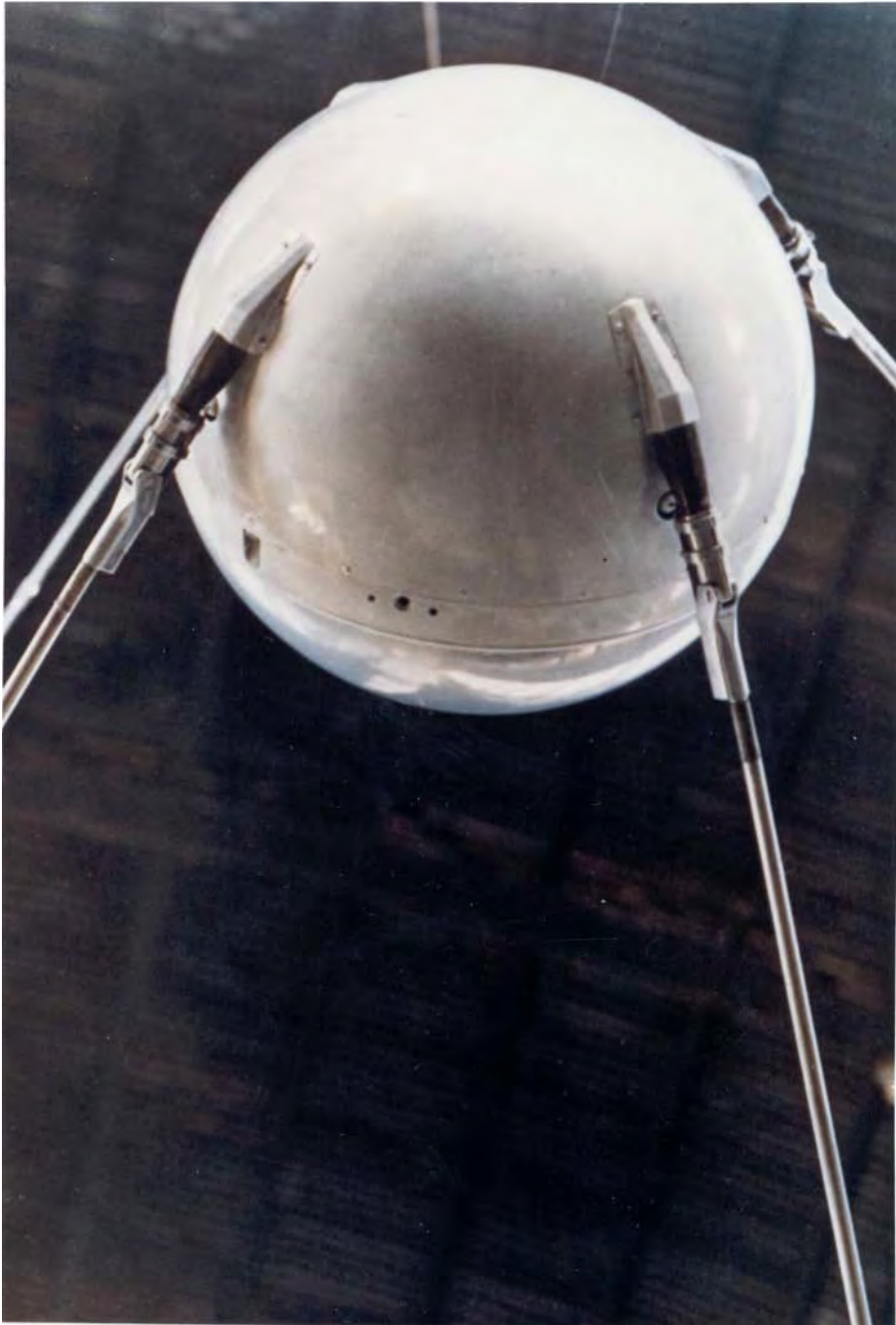

*"Sputnik: The Fiftieth Anniversary", 2007, Photo Gallery. Retrieved November 29, 2007, from <http://www.history.nasa.gov/sputnik/gallerysput.html>*

Figure 15P-3 Sputnik



*"Sputnik: The Fiftieth Anniversary", 2007, Photo Gallery. Retrieved November 29, 2007, from <http://www.history.nasa.gov/sputnik/gallerysput.html>*

Figure 15P-4 Sputnik Revealed

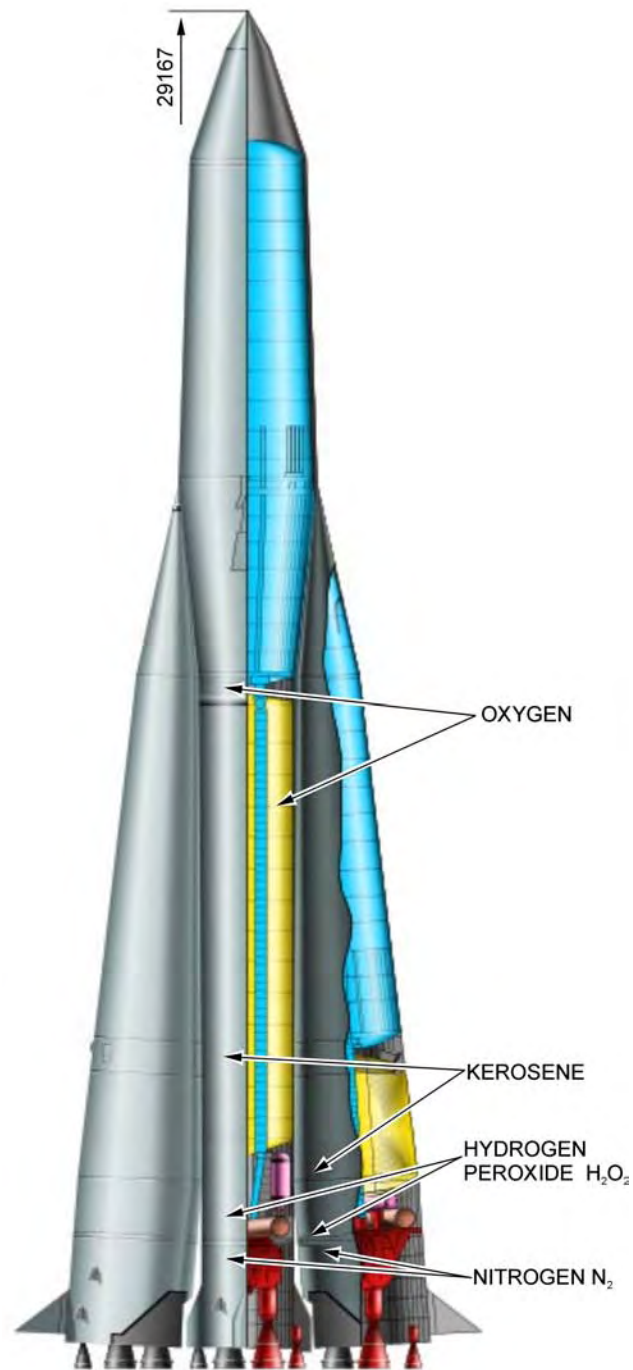

*"Roscosmos", Space Programs Rocket Families R-7. Retrieved March 25, 2007, from <http://www.roscosmos.ru/Rocket1Show.asp?RocketID=8>*

Figure 15P-5 Sputnik's R-7 Rocket



*"Russian Space Web", 2007, Rockets. Retrieved December 2, 2007, from <http://www.russianspaceweb.com/r7.html>*

Figure 15P-6 Two-Stage R-7 Rocket Modified for Sputnik-1

**Flight History JUPITER-C (three-stage configuration):**

September 20, 1956: Lofted a payload to an altitude of 1 095 km and a range of 5 313 km from Cape Canaveral, Florida.

May 15, 1957: Lofted a nose cone to an altitude of 563 km and a range of 1 143 km.

August 8, 1957: Lofted a 1/3-scale Jupiter nose cone to an altitude of 459 km and a range of 2 141 km.

January 31, 1958: Orbited Explorer-1 satellite.

March 5, 1958: Attempted orbit of Explorer-II failed because fourth stage did not ignite.

March 26, 1958: Orbited Explorer-III satellite.

July 26, 1958: Orbited Explorer-IV satellite.

August 24, 1958: Attempted orbit of Explorer-V satellite failed because booster collided with second stage after separation, causing the upper stage firing angle to be off.

October 23, 1958: Attempted orbit of inflatable Beacon satellite failed when second stage separated prematurely from booster.

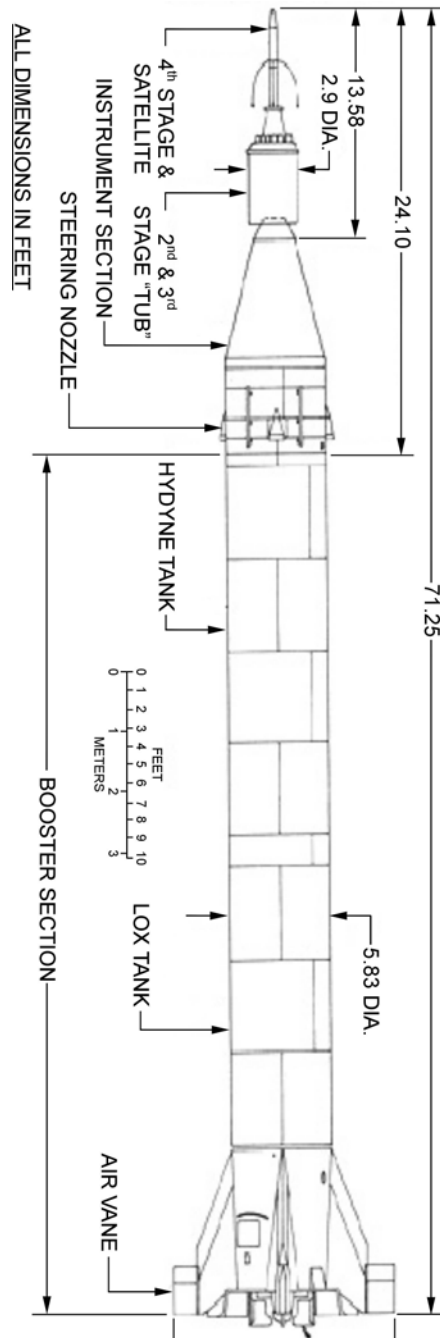

"Sputnik: The Fiftieth Anniversary", *Sputnik and The Dawn of the Space Age*. Retrieved March 25, 2007, from <http://history.nasa.gov/sputnik/expinfo.html>

Figure 15P-7 Jupiter-C and Explorer 1

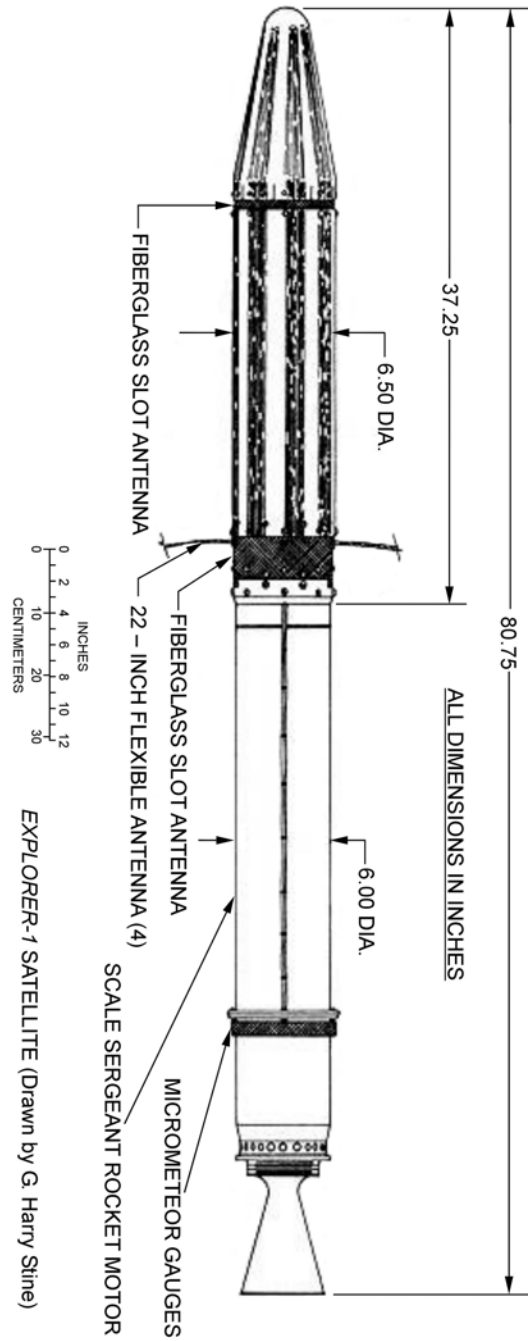
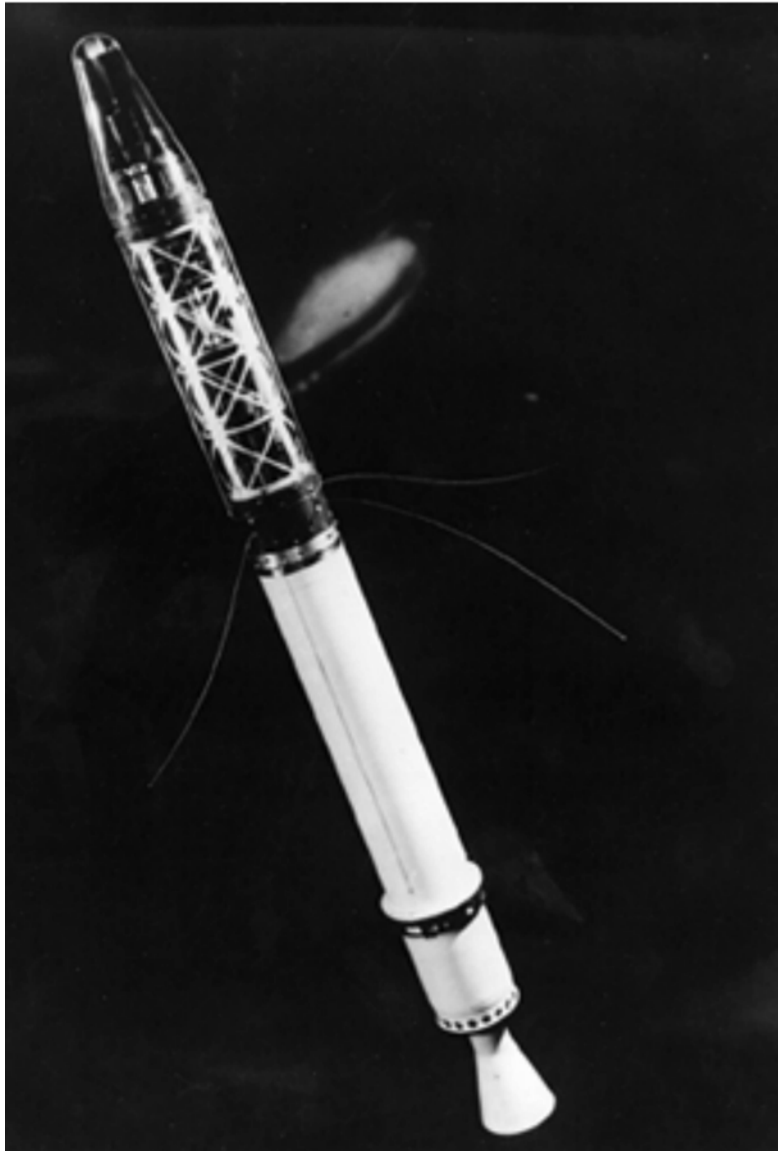

"Sputnik: The Fiftieth Anniversary", *Sputnik and The Dawn of the Space Age*. Retrieved March 25, 2007, from <http://history.nasa.gov/sputnik/expinfo.html>

Figure 15P-8 Explorer 1



### INTERSTELLAR MISSION

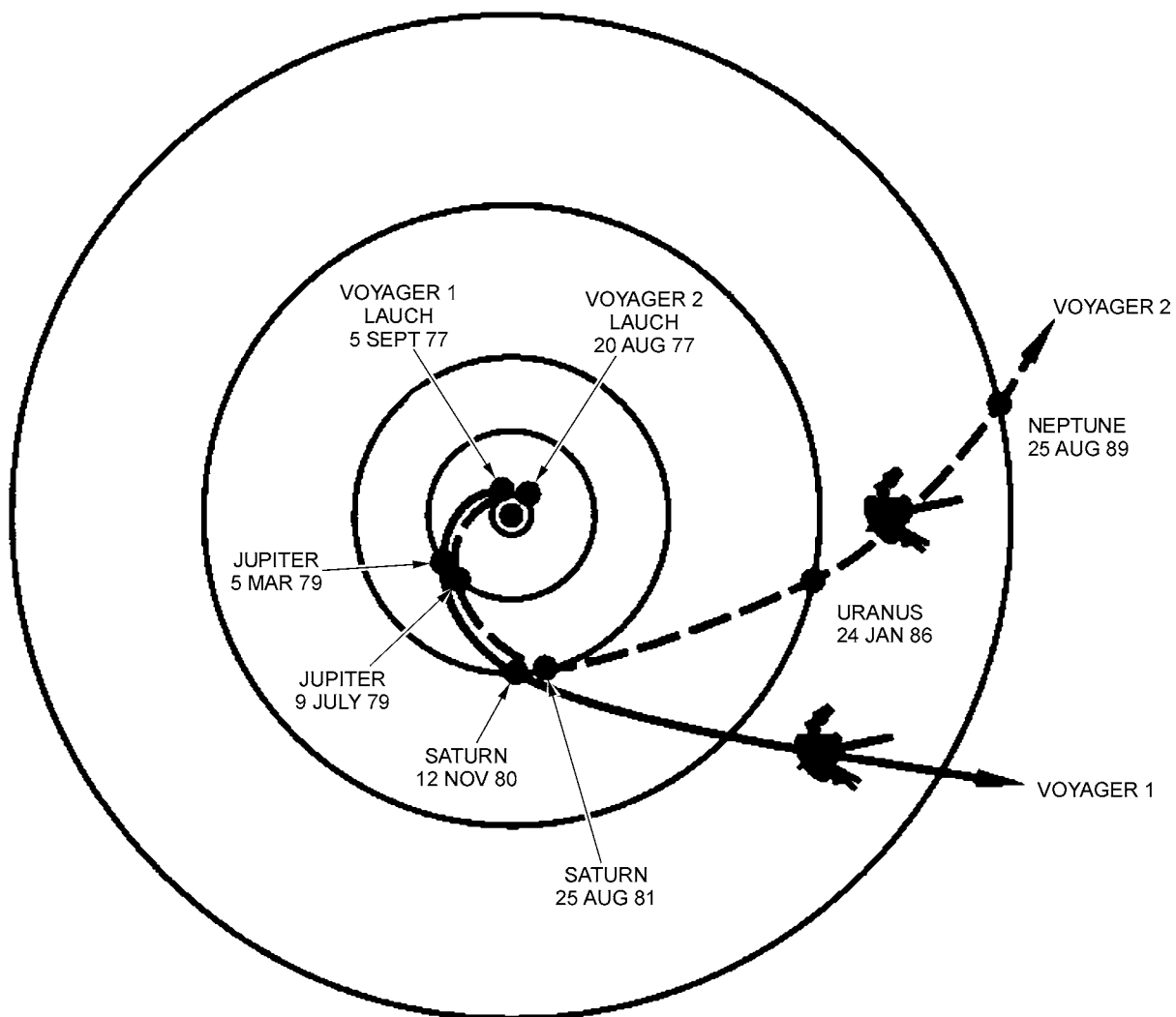

*"Voyager: The Interstellar Mission", by NASA, 2004, Planetary Voyage.  
Retrieved April 8, 2008, from <http://voyager.jpl.nasa.gov/science/heliocentric.html>*

Figure 15Q-1 Planetary Voyage

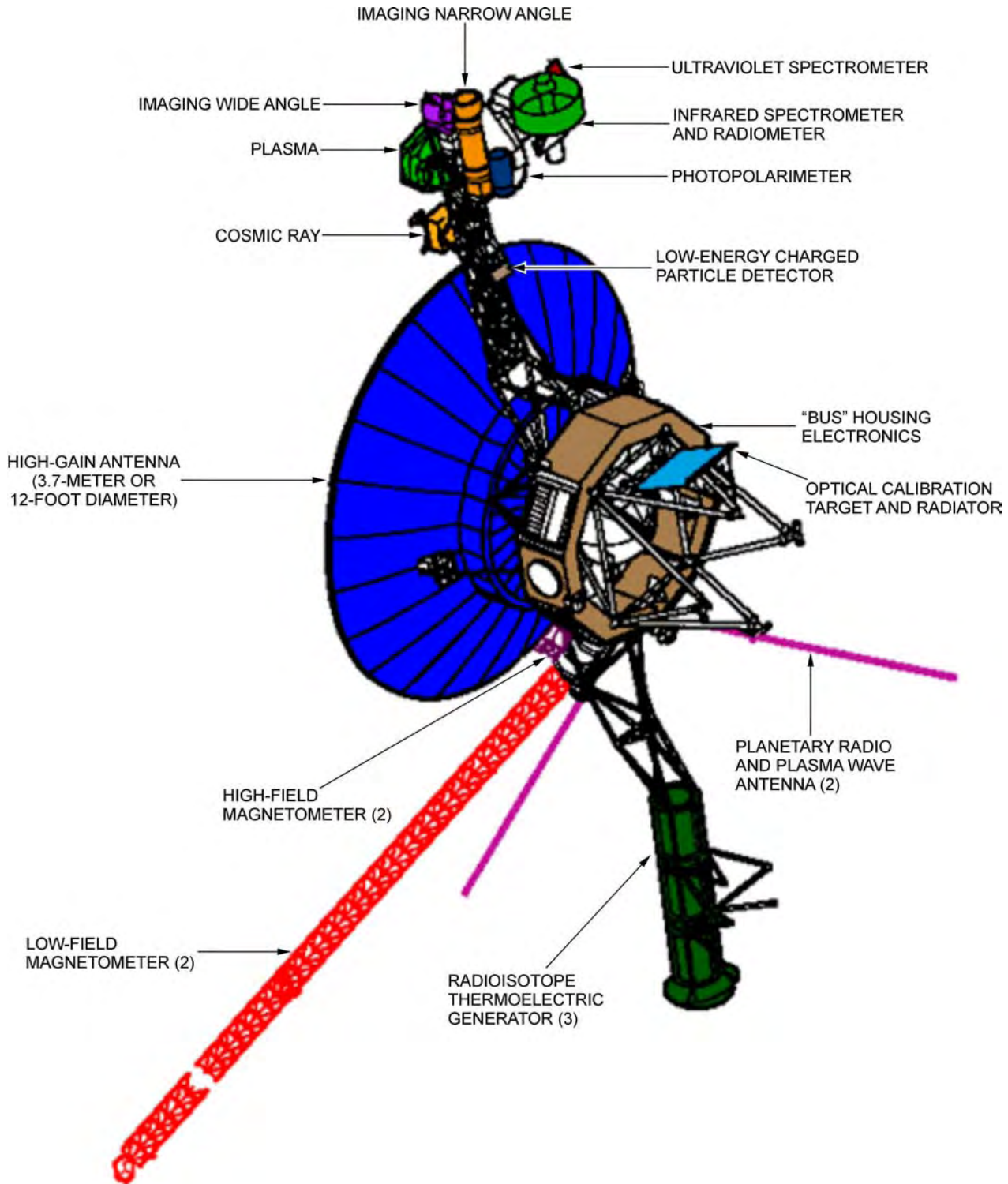

*"Voyager: The Interstellar Mission", by NASA, 2004, Voyager Spacecraft. Retrieved April 8, 2008, from <http://voyager.jpl.nasa.gov/spacecraft/instruments.html>*

Figure 15Q-2 Voyager Configuration

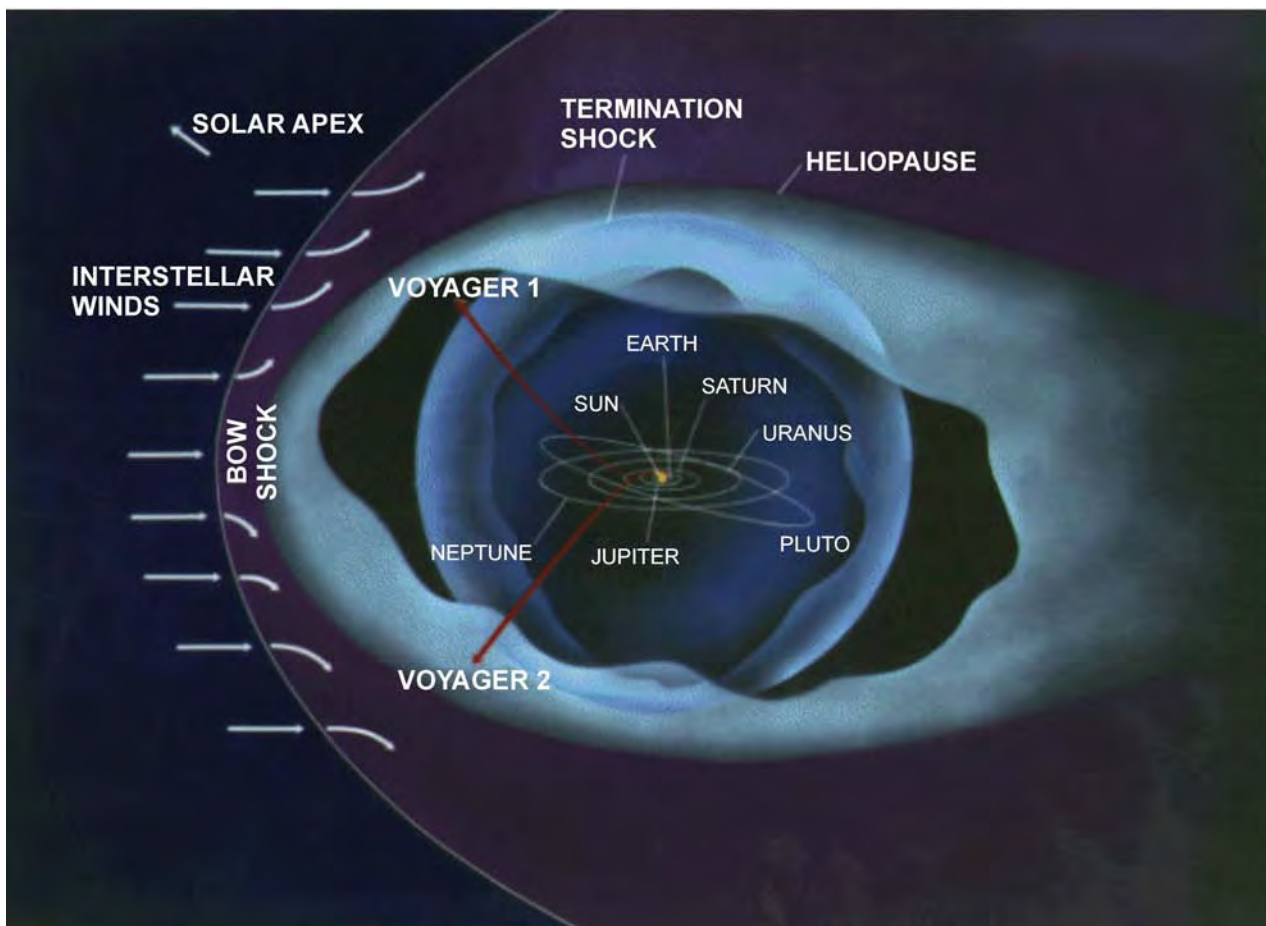

*"Voyager: The Interstellar Mission", by NASA, 2007, Overview. Retrieved April 8, 2008, from <http://voyager.jpl.nasa.gov/mission/mission.html>*

Figure 15Q-3 Voyager Interstellar Mission

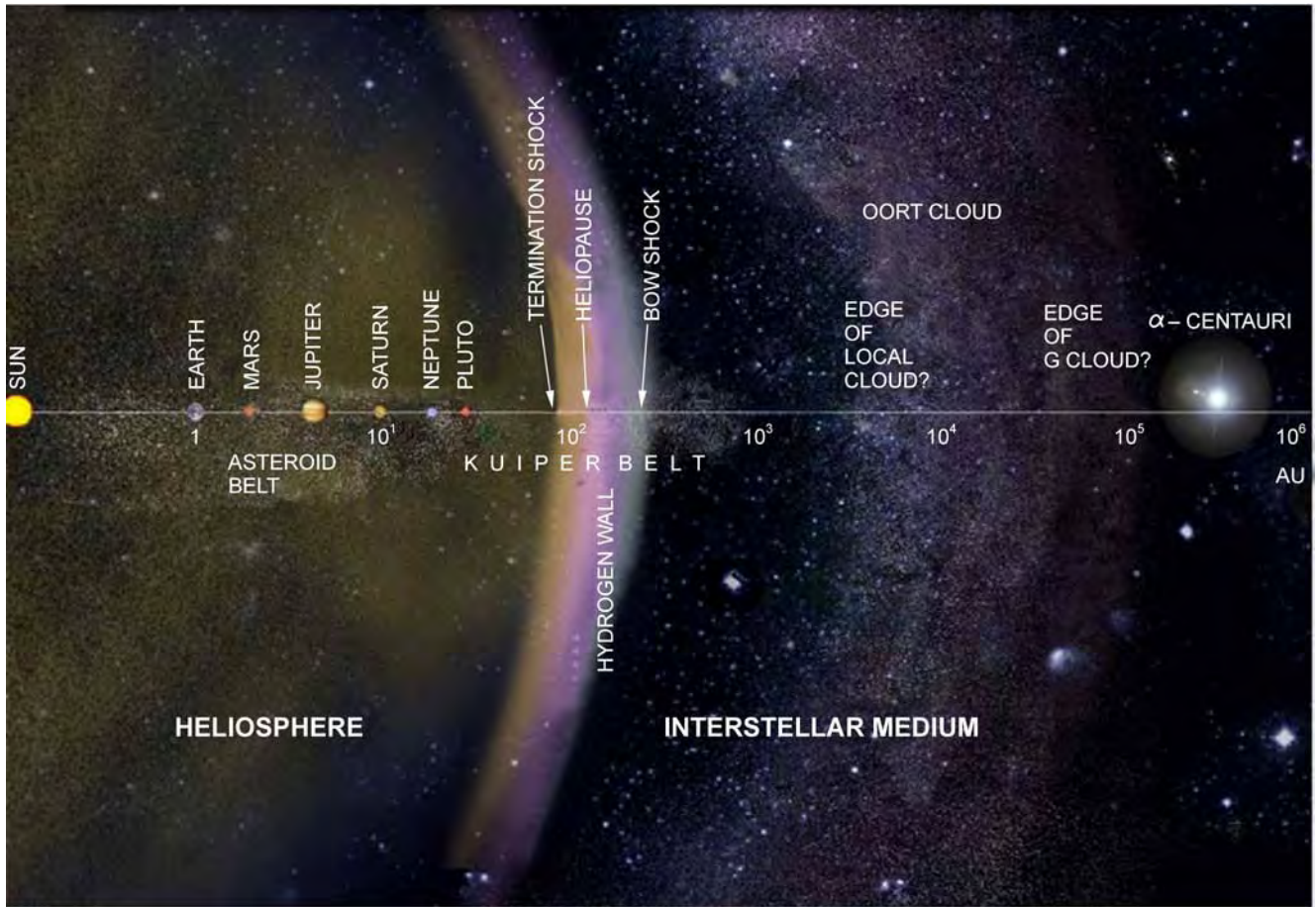

*“Voyager: The Interstellar Mission”, by NASA, 2004, Did You Know: Interesting Facts About the Voyager Mission. Retrieved April 8, 2008, from <http://voyager.jpl.nasa.gov/mission/didyouknow.html>*

Figure 15Q-4 Sol’s Heliopause

 For current distances of the Voyagers, cadets can check mission weekly reports at NASA website <http://voyager.jpl.nasa.gov/mission/weekly-reports/index.htm>.

The distance from earth to the sun (approximately 149 598 000 km – this dimension is not perfectly stable) is said to be one astronomical unit (AU). Such a huge unit of measure is useful when dealing with astronomical dimensions. The vertical dimension shown in Figure 15Q-4 is therefore approximately 5 AU. The horizontal dimension, however, includes all the space between earth’s sun, Sol, and Alpha Centauri – Sol’s closest neighbour – 277 600 AU. To cover this vast space, the horizontal scale was altered so that it increases as the viewer moves from left to right. The scale changes are marked on the central horizontal line, as  $10^1, 10^2, 10^3, 10^4, 10^5$  and  $10^6$ . This means that the distance between each pair of marks on the horizontal line is ten times larger than the distance between the preceding pairs of marks. That is, Saturn’s orbit is only 10 AU from the sun,  $10^3$  is one thousand AU from the sun, while  $10^6$  is one million AU from the sun – well past Alpha Centauri. This method (logarithmic representation) is necessary for representing astronomical distances.

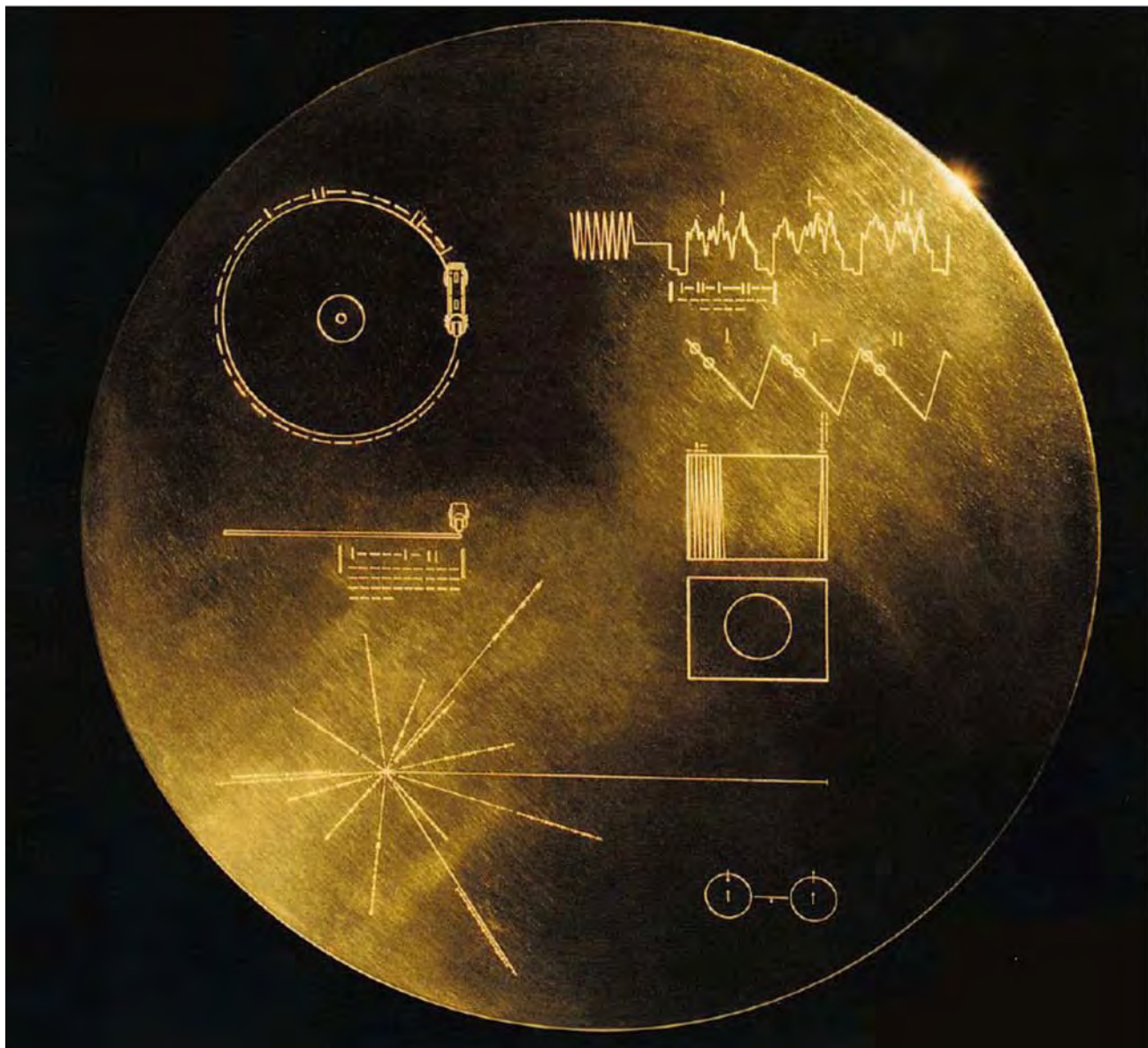

*"Voyager: The Interstellar Mission", by NASA, 2003, The Golden Record. Retrieved April 8, 2008, from <http://voyager.jpl.nasa.gov/spacecraft/goldenrec1.html>*

Figure 15Q-5 The Golden Record

THIS PAGE INTENTIONALLY LEFT BLANK

## MARS MISSION



*"Phoenix Mars Mission", by NASA, 2008, The Spacecraft. Retrieved April 6, 2008 from <http://phoenix.lpl.arizona.edu/images.php?gID=301&cID=1>*

Figure 15R-1 Phoenix Mars Lander

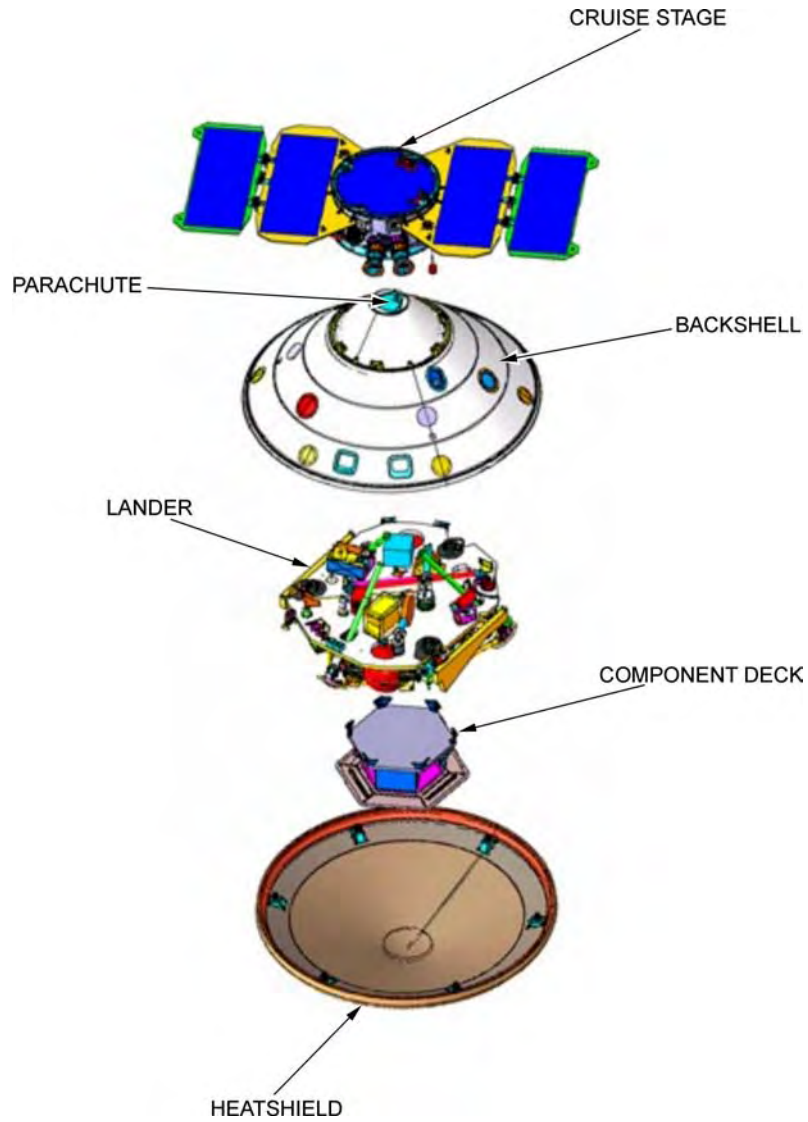

*"Phoenix Mars Mission", by NASA, 2008, The Spacecraft. Retrieved April 6, 2008, from <http://phoenix.lpl.arizona.edu/images.php?gID=301&cID=1>*

Figure 15R-2 Phoenix Revealed





"Phoenix Mars Mission", by NASA, 2008, The Spacecraft. Retrieved April 6, 2008, from <http://phoenix.lpl.arizona.edu/images.php?gID=301&cID=1>

Figure 15R-4 Jettisoning the Cruise Stage at Entry Minus 5 Min



"Phoenix Mars Mission", by NASA, 2008, The Spacecraft. Retrieved April 6, 2008, from <http://phoenix.lpl.arizona.edu/images.php?gID=301&cID=1>

Figure 15R-3 Testing the Spacecraft

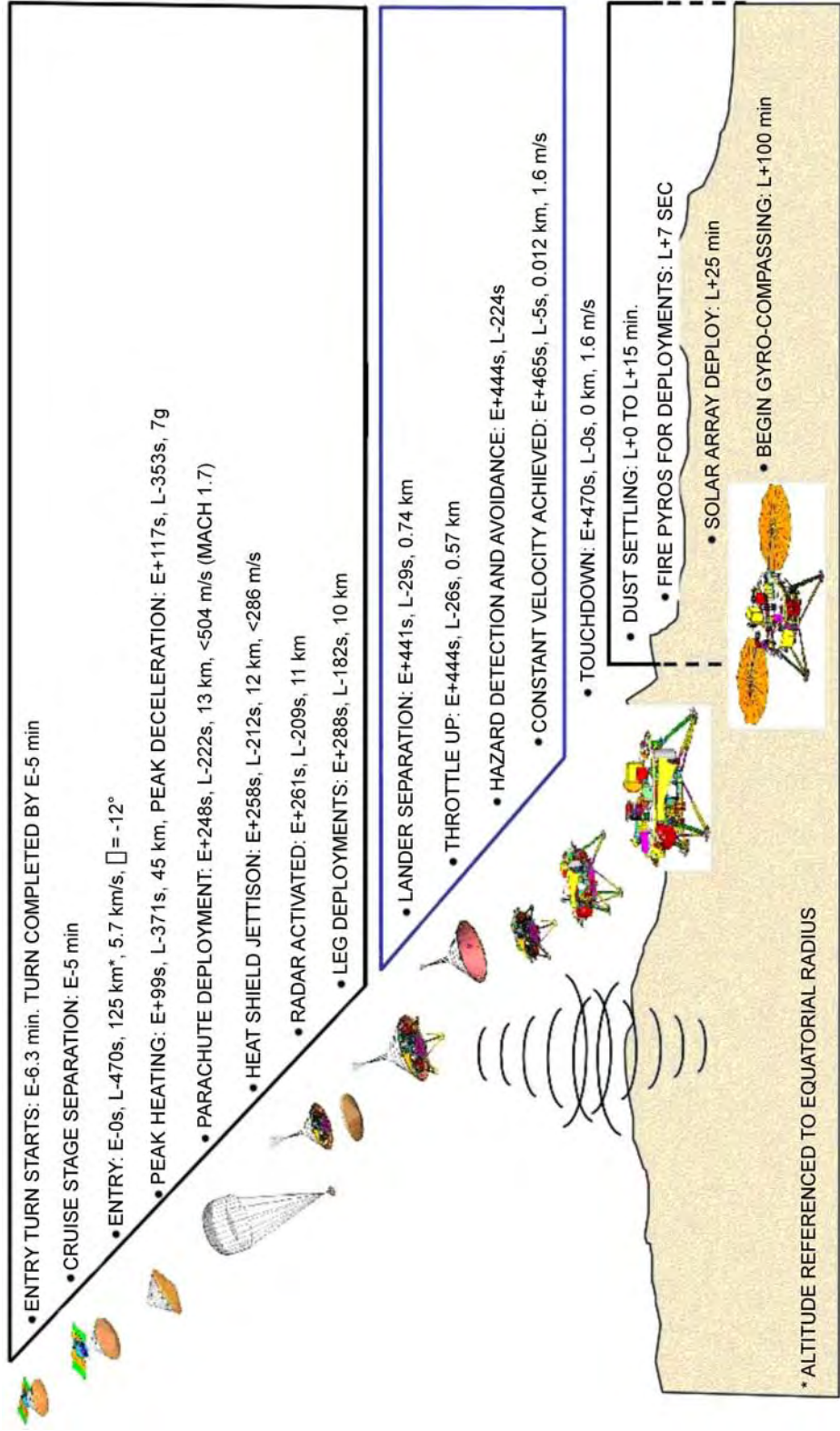

"Phoenix Mars Mission", by NASA, 2008, *The Spacecraft*. Retrieved April 6, 2008 from <http://phoenix.lpl.arizona.edu/images.php?gID=301&cID=1>

Figure 15R-5 Phoenix Arriving

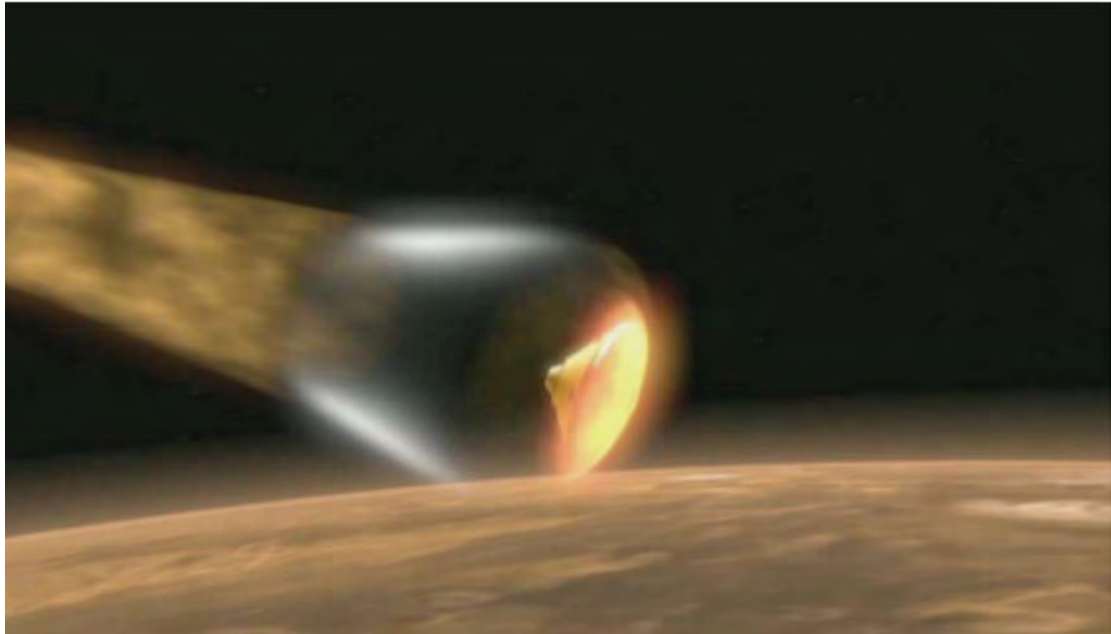

*"Phoenix Mars Mission", by NASA, 2008, The Spacecraft. Retrieved April 6, 2008 from <http://phoenix.lpl.arizona.edu/images.php?gID=301&cID=1>*

Figure 15R-6 Entering the Martian Atmosphere at Entry Plus 99 Seconds



*"Phoenix Mars Mission", by NASA, 2008, The Spacecraft. Retrieved April 6, 2008 from <http://phoenix.lpl.arizona.edu/images.php?gID=301&cID=1>*

Figure 15R-7 Powered Landing on Mars at Entry Plus 470 Seconds

THIS PAGE INTENTIONALLY LEFT BLANK

## MOONS VIDEO WORKSHEET

- Notes:**
1. The information is encountered in the same order as the questions.
  2. Read the questions carefully before beginning the MOONS video.

### QUESTIONS

1. How long ago do scientists think that Earth's moon was formed? \_\_\_\_\_
2. How many years did NASA's Galileo probe spend exploring Jupiter's moons? \_\_\_\_\_
3. What lies under Europa's frozen crust? \_\_\_\_\_
4. What year did the European Space agency launch Cassini-Huygens? \_\_\_\_\_
5. How long did it take the Cassini-Huygens probe to travel to Saturn? \_\_\_\_\_
6. What kind of scientist is the narrator, Athena Coustenis? \_\_\_\_\_
7. What is Saturn's most distant moon? \_\_\_\_\_
8. What year did Jean-Dominique Cassini discover Saturn's moon Iapetus? \_\_\_\_\_
9. Half of Iapetus is dark as coal; what is the other half? \_\_\_\_\_
10. What runs around the equator of Iapetus? \_\_\_\_\_
11. What is the largest moon of Saturn? \_\_\_\_\_
12. What year did the Cassini spacecraft release the Huygens probe to visit Titan? \_\_\_\_\_
13. How long did Huygens operate on Titan's surface? \_\_\_\_\_



While on final approach for its September 2007 close encounter with Saturn's moon, Iapetus, Cassini spun around to take in a sweeping view of the Saturn System. Iapetus (1 468 km, or 912 miles across) is the only major moon of Saturn with a significant inclination to its orbit. From the other major satellites, the rings would appear nearly edge-on, but from Iapetus, the rings usually appear at a tilt, as seen here.

Moons visible in this image: **Dione** (1 126 km diameter) at center left, **Enceladus** (505 km diameter) near the left side ansa (or ring edge), **Mimas** (397 km diameter) a speck against the ring shadows on Saturn's western limb, **Rhea** (1 528 km diameter) against the bluish backdrop of the northern hemisphere, **Tethys** (1 071 km diameter) near the right ansa, and **Titan** (5 150 km diameter) near lower right.

The images were obtained on September 10, 2007, at a distance of approximately 3.3 million km from Saturn at a sun-Saturn-spacecraft, or phase, angle of 33 degrees. Image scale is about 195 km per pixel on the planet.

*"JPL PHOTOJOURNAL", by NASA, 2007, PIA08387: The View from Iapetus.  
Retrieved April 6, 2008, from <http://photojournal.jpl.nasa.gov/catalog/PIA08387>*

Figure 15S-1 Saturn, Enceladus and Titan

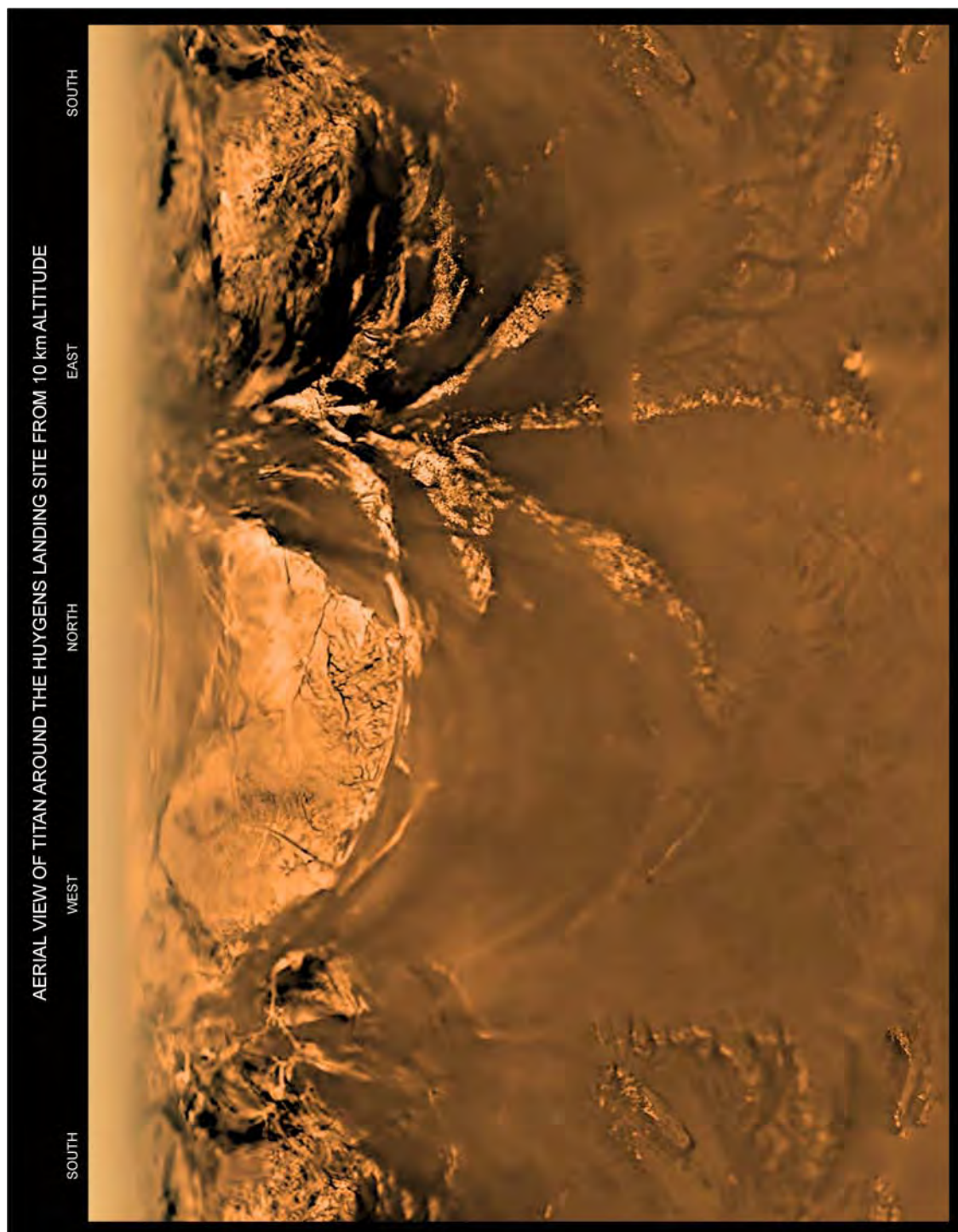

ESA Multimedia Gallery, 2008, Mercator Projection of Huygens's View. Retrieved April 6, 2008, from <http://www.esa.int/esa-mmg/mmg.pl?b=b&keyword=titan%20huygens&single=y&start=25&size=b>

Figure 15S-2 Huygen's Descent



*"ESA Multimedia Gallery", 2008, Titan's Surface. Retrieved April 6, 2008, from <http://www.esa.int/esa-mm/mmg.pl?b=b&keyword=titan%20huygens&start=3>*

Figure 15S-3 Huygen's Resting Place





*"JPL Cassini-Huygens Mission to Saturn & Titan", 2008, Jet Blue. Retrieved April 6, 2008, from <http://saturn.jpl.nasa.gov/multimedia/images/image-details.cfm?imageID=2779>*

Figure 15S-4 The Fountains of Enceladus

Enceladus [en-SELL-ah-dus] is one of the innermost moons of Saturn. Enceladus reflects almost 100 percent of the sunlight that strikes it. Parts of Enceladus show craters 35 km in diameter. Other areas show regions with no craters indicating major resurfacing events in the geologically recent past. There are fissures, plains, corrugated terrain and other crustal deformations. All of this indicates that the interior of the moon may be liquid today, even though it should have frozen eons ago. It is postulated that Enceladus is heated by a tidal mechanism. It is disturbed in its orbit by Saturn's gravitational field and by the large neighbouring satellites Tethys and Dione. Enceladus reflects so much sunlight that its surface temperature is only -201 degrees C (-330 degrees F).

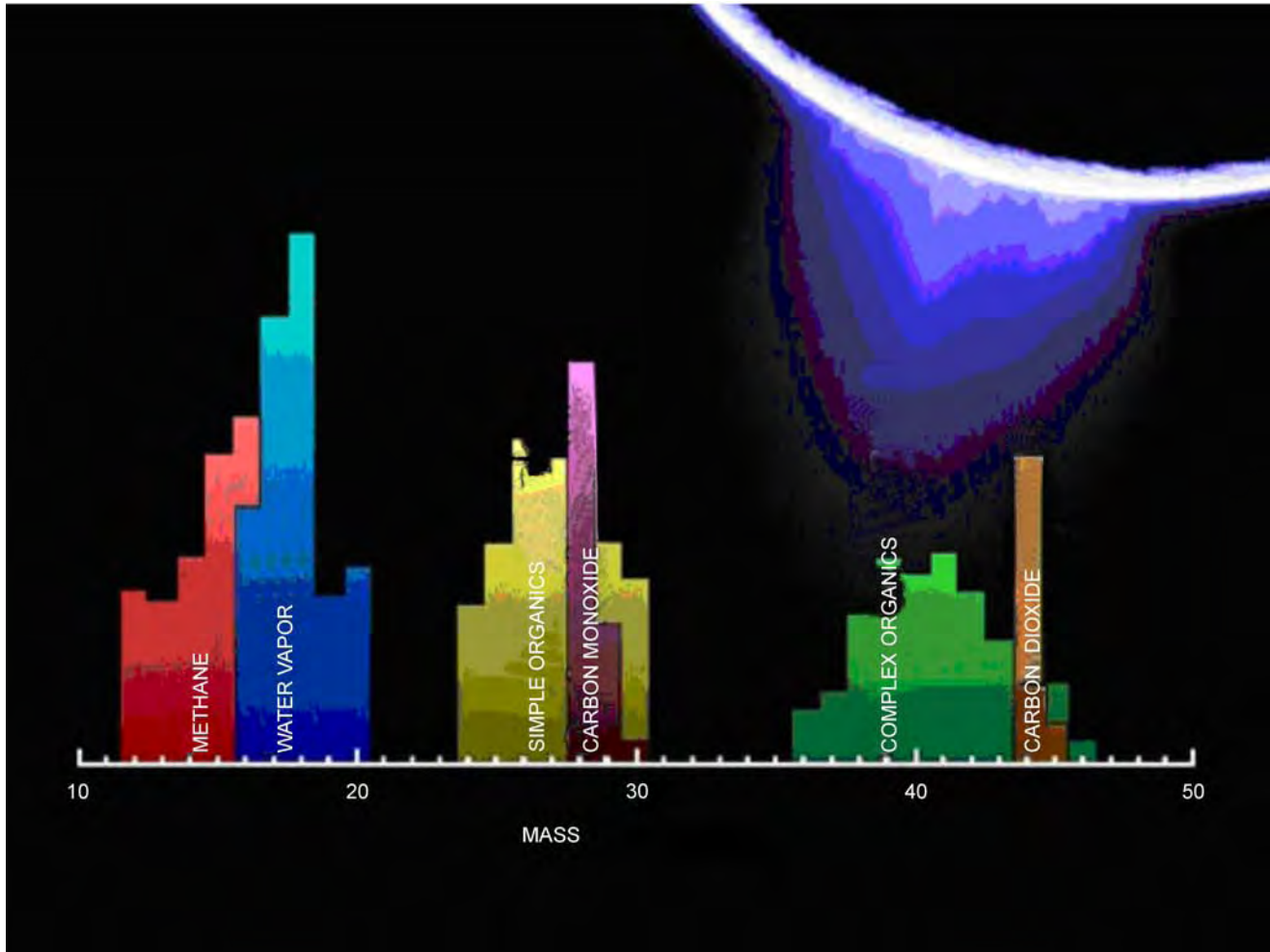

*"Cassini: Unlocking Saturn's Secrets", NASA, 2008, Enceladus Plume Neutral Mass Spectrum. Retrieved April 6, 2008, from [http://www.nasa.gov/mission\\_pages/cassini/multimedia/pia10356.html](http://www.nasa.gov/mission_pages/cassini/multimedia/pia10356.html)*

Figure 15S-5 Composition of Enceladus' Water Plumes

**ANSWERS TO MOONS VIDEO WORKSHEET**

1. How long ago do scientists think that Earth's moon was formed? **4.5 billion years**
2. How many years did NASA's Galileo probe spend exploring Jupiter's moons? **8 years**
3. What lies under Europa's frozen crust? **A liquid ocean**
4. What year did the European Space agency launch Cassini-Huygens? **1997**
5. How long did it take the Cassini-Huygens probe to travel to Saturn? **7 years**
6. What kind of scientist is the narrator, Athena Coustenis? **Astrophysicist**
7. What is Saturn's most distant moon? **Phoebe**
8. What year did Jean-Dominique Cassini discover Saturn's moon Iapetus? **1671**
9. Half of Iapetus is dark as coal; what is the other half? **Bright as snow**
10. What runs around the equator of Iapetus? **An icy ridge**
11. What is the largest moon of Saturn? **Titan**
12. What year did the Cassini spacecraft release the Huygens probe to visit Titan? **2005**
13. How long did Huygens operate on Titan's surface? **Barely a few minutes**

THIS PAGE INTENTIONALLY LEFT BLANK

## CONSTELLATIONS



*Catching the Light: Astrophotography by Jerry Lodriguss, 1998. Retrieved March 1, 2008, from [http://www.astropix.com/HTML/C\\_SPRING/BIGDIP.HTM](http://www.astropix.com/HTML/C_SPRING/BIGDIP.HTM)*

Figure 15U-1 The Big Dipper in Constellation Ursa Major

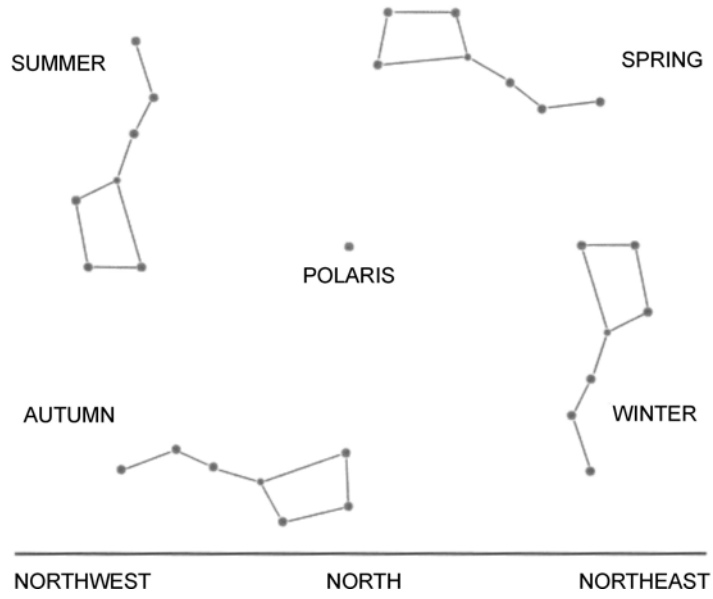

*T. Dickinson, NightWatch: A Practical Guide to Viewing the Universe, Firefly Books Ltd. (p. 31)*

Figure 15U-2 Orientations of the Big Dipper

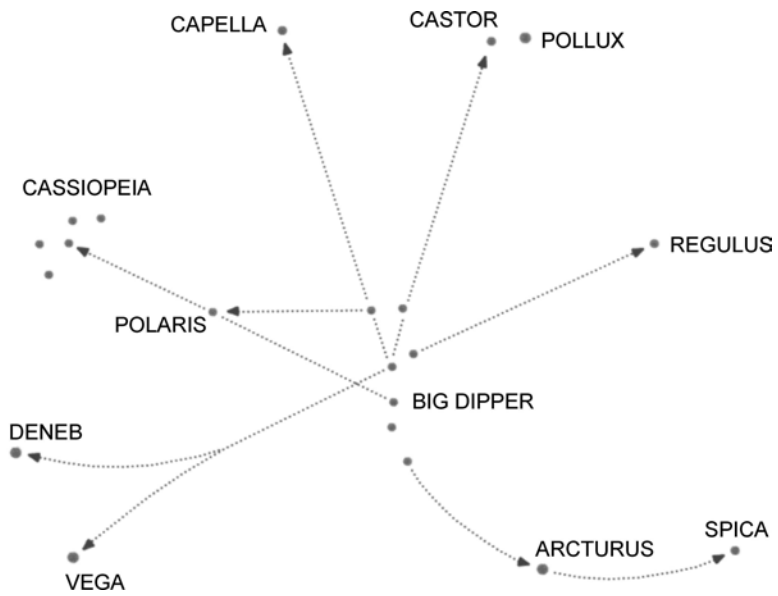

*T. Dickinson, NightWatch: A Practical Guide to Viewing the Universe, Firefly Books Ltd. (p. 31)*

Figure 15U-3 Big Dipper as the Key to the Night Sky



*Constellations, by National Research Council of Canada. Retrieved March 1, 2008, from [http://www.nrc-cnrc.gc.ca/docs/education/planisphere\\_e.pdf](http://www.nrc-cnrc.gc.ca/docs/education/planisphere_e.pdf)*

Figure 15U-4 Constellations

Constellations are patterns of stars partitioned and named long ago by our ancestors. Of the 88 constellations recognized by the International Astronomical Union approximately one quarter of these are in the southern sky and not visible from mid-northern latitudes. About half of the remaining constellations are faint and hard to distinguish. Many of the visible and well-known constellations are shown in this handout. All constellations, including Ursa Major (the Big Dipper), circle the sky every 24 hours, with Polaris – the North Star – at the centre of the circle.



### SIGHTING OPPORTUNITIES

On February 8, 2008, the space shuttle Atlantis, flying mission STS-122, was delivering the European Space Agency's (ESA) Columbus Laboratory module to the International Space Station (ISS). This momentous event brought the ESA's Columbus Control Center in Oberpfaffenhofen, Germany online for the first time. Coincidentally, the Progress P28 supply ship had just arrived from the Baikonur Cosmodrome in Kazakhstan the previous day to replace Progress P27 which was then de-orbited to burn up in the earth's atmosphere. The sighting opportunities listed below show not only the ISS and Atlantis, but also a last glimpse of Progress P27 before final re-entry.

**ONLY DAYS WITH SIGHTING OPPORTUNITIES ARE LISTED**

**THE FOLLOWING SHUTTLE SIGHTINGS ARE POSSIBLE FROM FRI FEB 08 TO SUN FEB 24**

SATELLITE	LOCAL DATE/TIME	DURATION (MIN)	MAX ELEV (DEG)	APPROACH (DEG-DIR)	DEPARTURE (DEG-DIR)
SHUTTLE	Fri Feb 08/07:17 PM	< 1	24	18 above WNW	24 above NW

**ONLY DAYS WITH SIGHTING OPPORTUNITIES ARE LISTED**

**THE FOLLOWING PROGRESS SIGHTINGS ARE POSSIBLE FROM FRI FEB 08 TO SAT FEB 16**

SATELLITE	LOCAL DATE/TIME	DURATION (MIN)	MAX ELEV (DEG)	APPROACH (DEG-DIR)	DEPARTURE (DEG-DIR)
PROGRESS	Fri Feb 08/07:14 PM	1	48	20 above WNW	48 above NNW

**THE FOLLOWING ISS SIGHTINGS ARE POSSIBLE FROM FRI FEB 08 TO WED FEB 20**

SATELLITE	LOCAL DATE/TIME	DURATION (MIN)	MAX ELEV (DEG)	APPROACH (DEG-DIR)	DEPARTURE (DEG-DIR)
ISS	Fri Feb 08/07:04 PM	2	51	20 above WNW	51 above N

*HUMANSPEACEFLIGHT: Sighting Opportunities by NASA, 2003. Retrieved February 8, 2008, from <http://spaceflight.nasa.gov/realdata/sightings/>*

Figure 15V-1 Sighting Opportunities

SATELLITE	LOCAL DATE/TIME	DURATION (MIN)	MAX ELEV (DEG)	APPROACH (DEG-DIR)	DEPARTURE (DEG-DIR)
ISS	Tue Nov 14/06:22 AM	4	66	10 above WSW	31 above NE

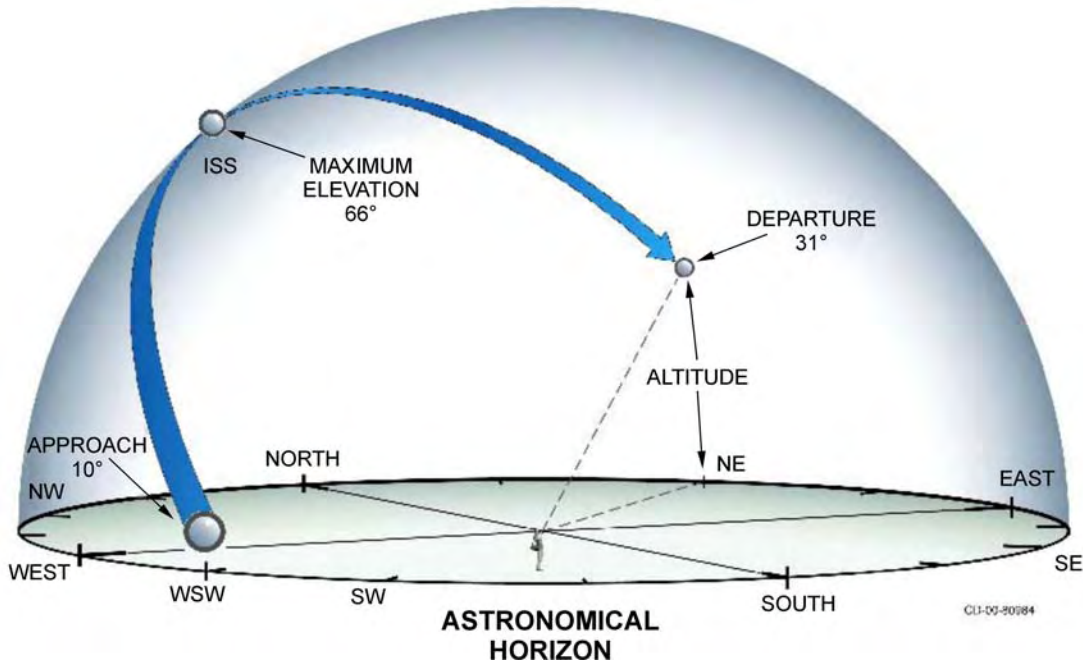

*HUMANSPACEFLIGHT: Sighting Opportunities by NASA, 2003. Retrieved March 1, 2008, from [http://spaceflight.nasa.gov/realdata/sightings/GIF/large\\_sighting.jpg](http://spaceflight.nasa.gov/realdata/sightings/GIF/large_sighting.jpg)*

Figure 15V-2 Morning ISS Sighting

### Viewing Tips

For best results, observers should look in the direction and at the elevation shown in the second column at the time listed. Telescopes are not practical because of the speed of the orbiting vehicles. However, a good pair of field binoculars may reveal some detail of the structural shape of the spacecraft. On a regular basis, the space shuttle must get rid of excess supply and waste water by dumping them overboard through water spray nozzles. Viewing the shuttle at these times through binoculars or a telescope can reveal an even more spectacular view of the spacecraft and the ice crystals that form as the water is sprayed overboard. Although you can sometimes use a flight timeline to find out when scheduled dumps occur, NASA TV is more accurate. Check the sightings list to see if a sighting opportunity and water dump overlap.

Shuttle/station docking missions provide an exciting opportunity to see a double pass. On the day or two days before docking and after undocking, the shuttle and station will appear to be chasing each other across the night sky. They will follow the same flight path varying by only a few minutes. If the distance is close enough, they will actually appear in the sky at the same time.

## LAUNCHING PLATFORMS

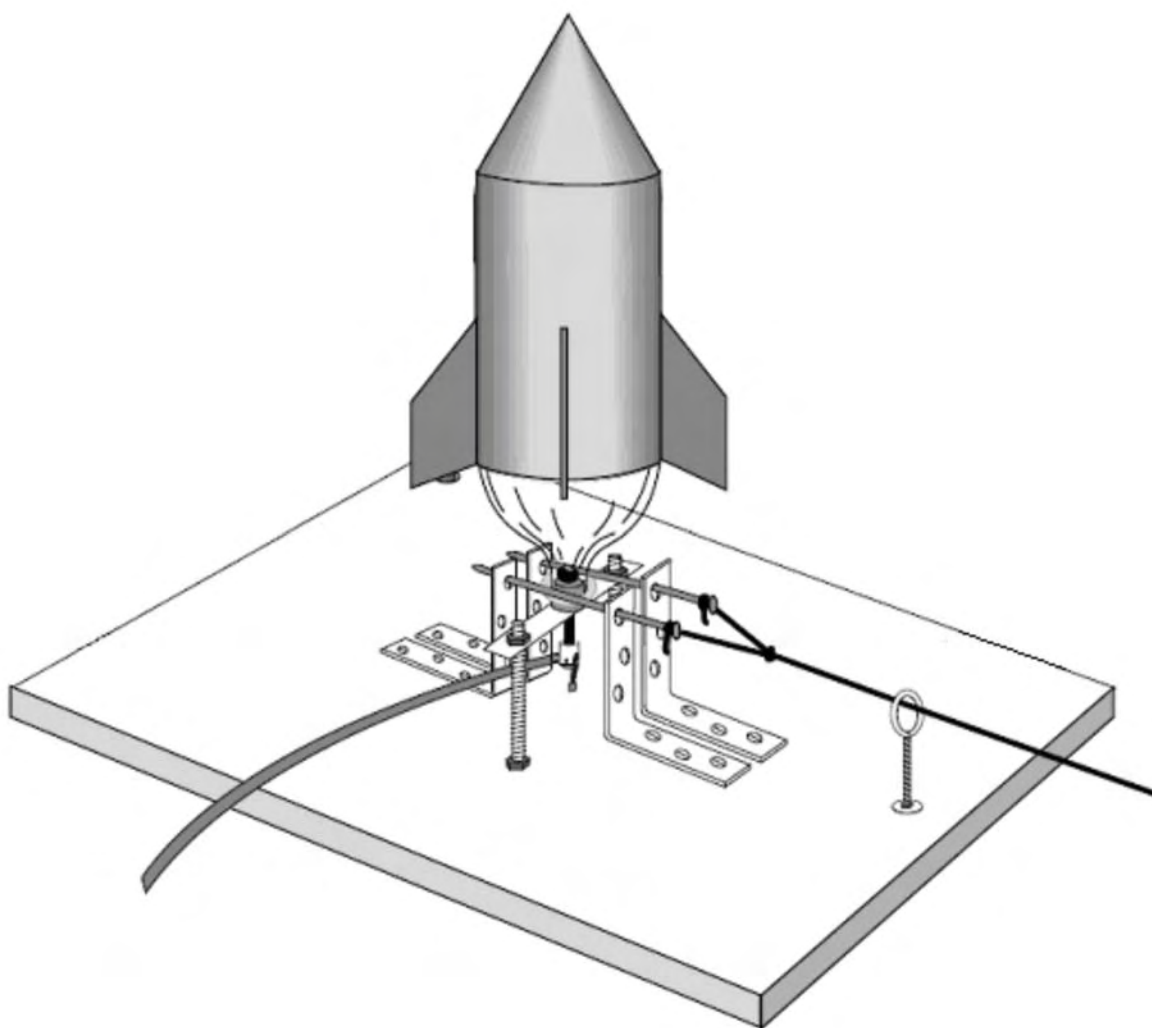

*"Rockets: A Teacher's Guide with Activities in Science, Mathematics, and Technology", by NASA, 2003, Bottle Rocket Launcher. Retrieved April 12, 2008, from [http://www.nasa.gov/pdf/153405main\\_Rockets.Guide.Bottle.Rocket.Launcher.pdf](http://www.nasa.gov/pdf/153405main_Rockets.Guide.Bottle.Rocket.Launcher.pdf)*

Figure 15W-1 Parts of the Launch Pad

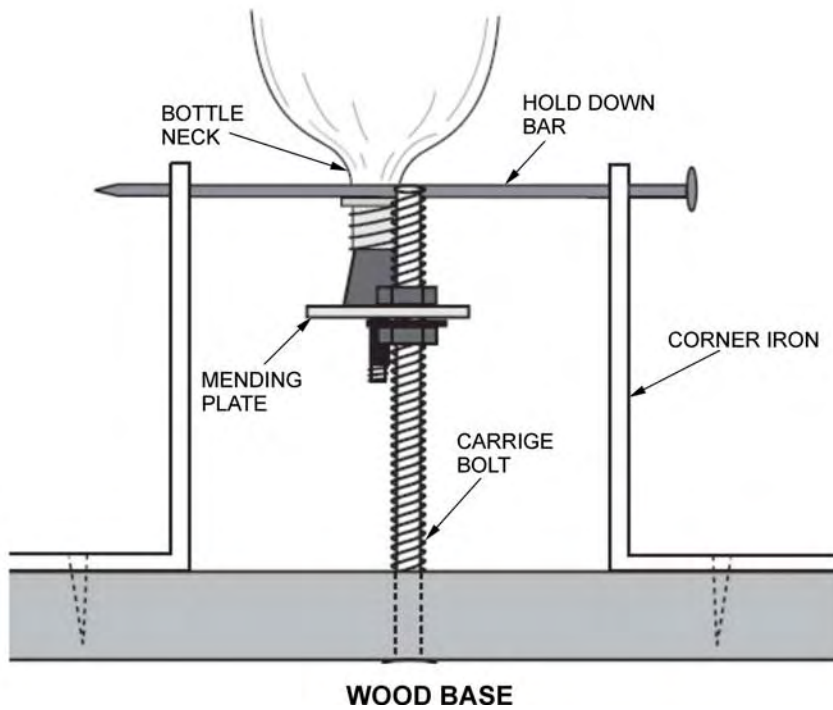
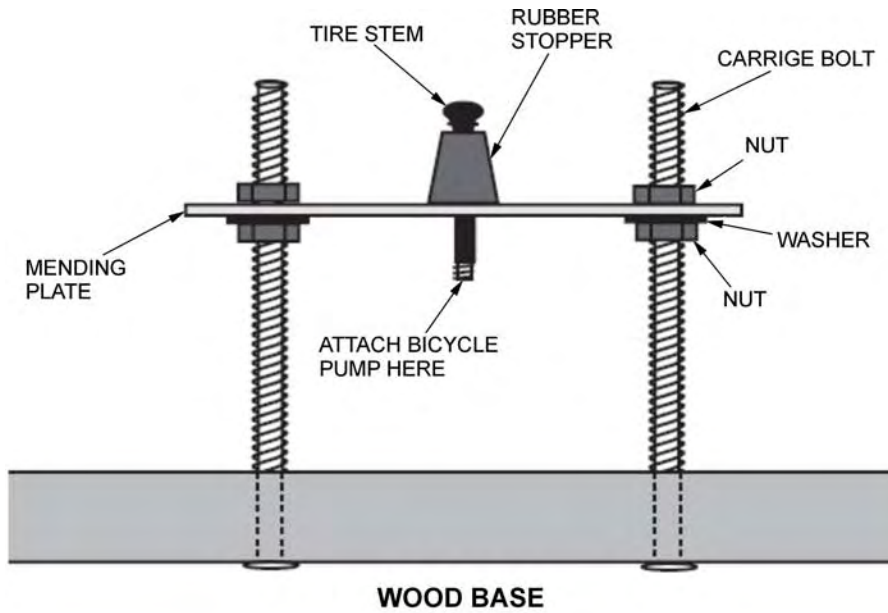

*"Rockets: A Teacher's Guide with Activities in Science, Mathematics, and Technology", by NASA, 2003, Bottle Rocket Launcher. Retrieved April 12, 2008, from [http://www.nasa.gov/pdf/153405main\\_Rockets.Guide.Bottle.Rocket.Launcher.pdf](http://www.nasa.gov/pdf/153405main_Rockets.Guide.Bottle.Rocket.Launcher.pdf)*

Figure 15W-2 Details of the Launch Pad

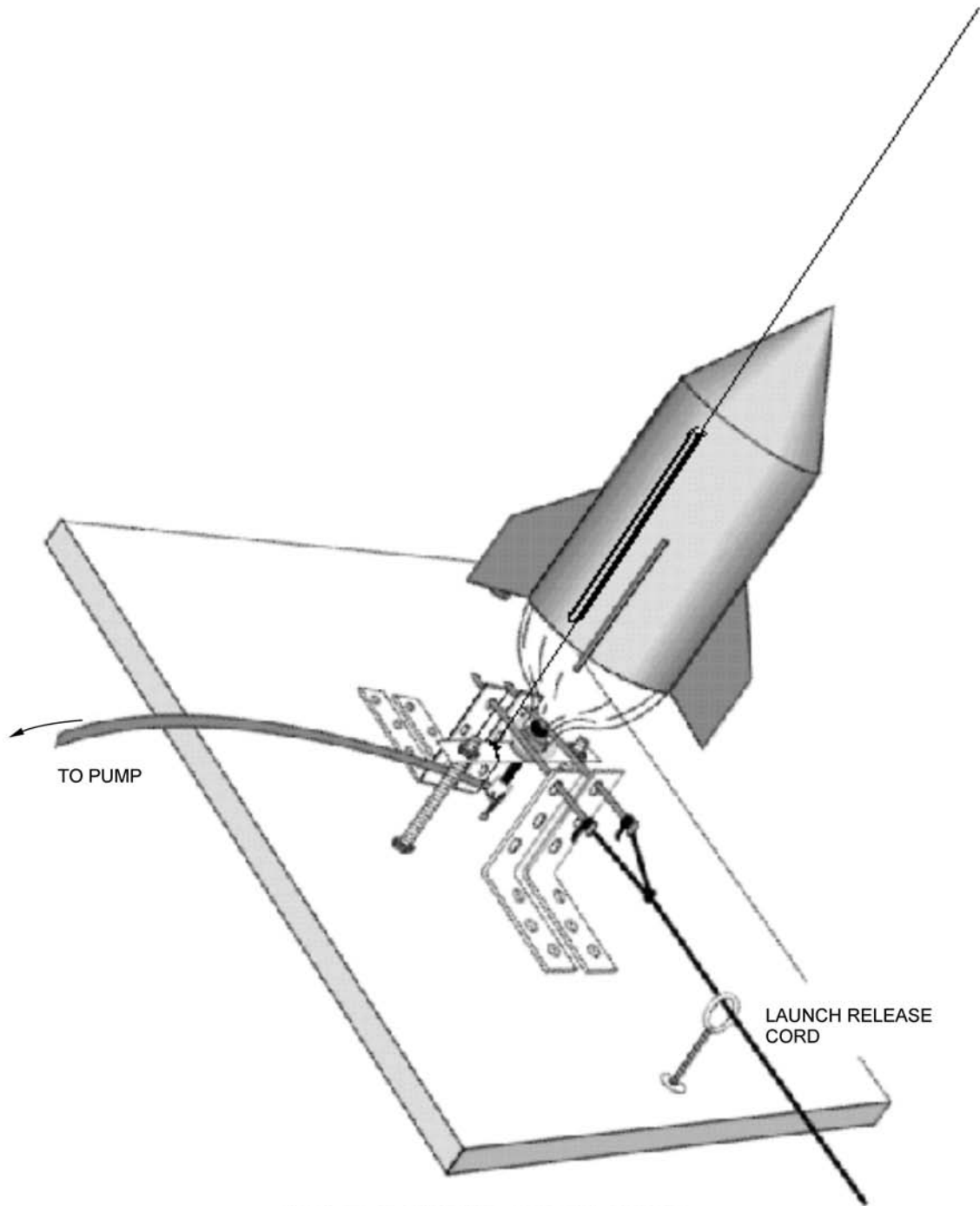

COMPLETED LAUNCHER READY FOR FIRING

*"Rockets: A Teacher's Guide with Activities in Science, Mathematics, and Technology", by NASA, 2003, Bottle Rocket Launcher. Retrieved April 12, 2008, from [http://www.nasa.gov/pdf/153405main\\_Rockets.Guide.Bottle.Rocket.Launcher.pdf](http://www.nasa.gov/pdf/153405main_Rockets.Guide.Bottle.Rocket.Launcher.pdf)*

Figure 15W-3 Launch Time

THIS PAGE INTENTIONALLY LEFT BLANK

### GUIDANCE SYSTEM

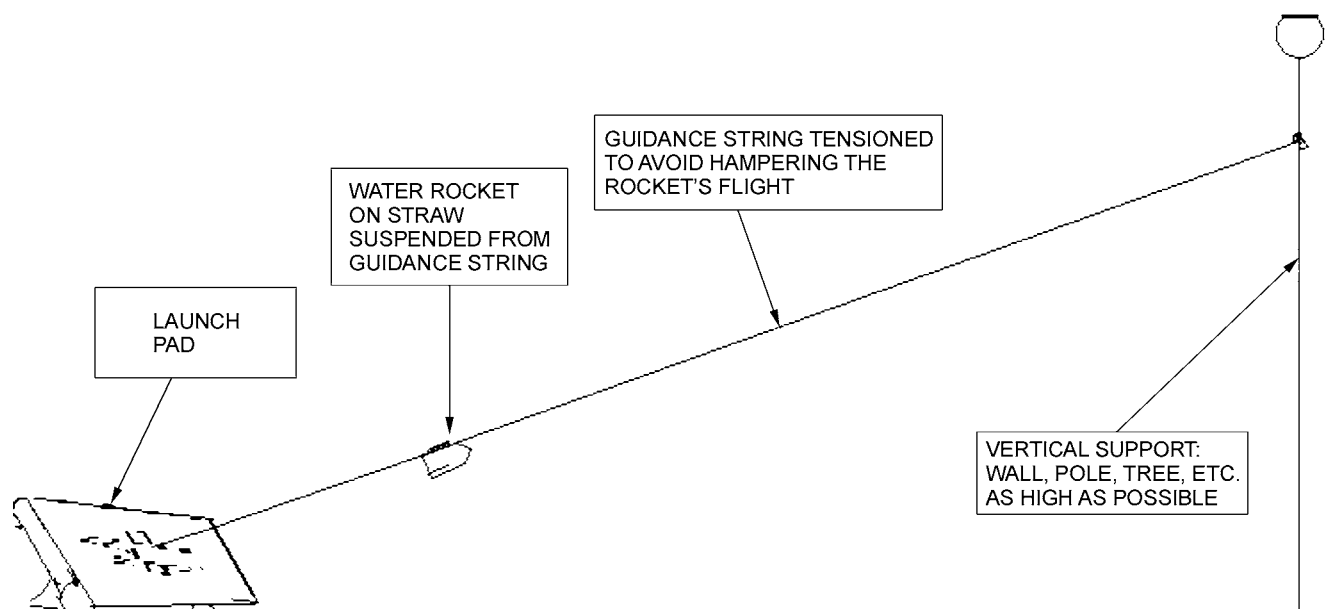

*Director Cadets 3, 2008, Ottawa, ON: Department of National Defence*

Figure 15X-1 String Guidance System

THIS PAGE INTENTIONALLY LEFT BLANK



## BUILDING A WATER ROCKET

### Materials Required:

- One-litre soft-drink bottles with caps,
- Construction paper,
- Tape,
- Glue,
- Drill and bits, and
- Putty or modelling clay.

### Hints For Construction:

- Do not allow glue to touch the plastic bottle as this may weaken the plastic and cause failure.
- Wrap and tape a tube of poster-board around the bottle.
- Cut out several fins of any shape and glue them to the tube.
- Form a nose cone and hold it together with tape or glue.
- Press a wad of modeling clay into the top of the nose cone for stability, if required.
- Tape the nose cone to upper end of bottle.
- Decorate your rocket.

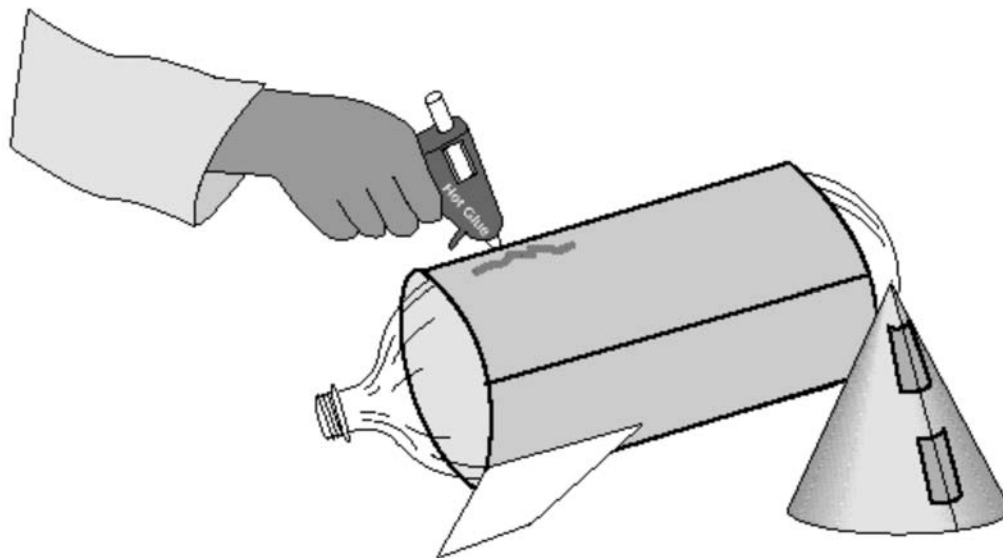

*"Rockets: A Teacher's Guide with Activities in Science, Mathematics, and Technology", by NASA, 2003, Bottle Rocket Launcher. Retrieved April 12, 2008, from [http://www.nasa.gov/audience/foreducators/topnav/materials/listbytype/Bottle\\_Rocket\\_Launcher.html](http://www.nasa.gov/audience/foreducators/topnav/materials/listbytype/Bottle_Rocket_Launcher.html)*

Figure 15Y-1 Building a Water Rocket

THIS PAGE INTENTIONALLY LEFT BLANK

### TRILATERATION

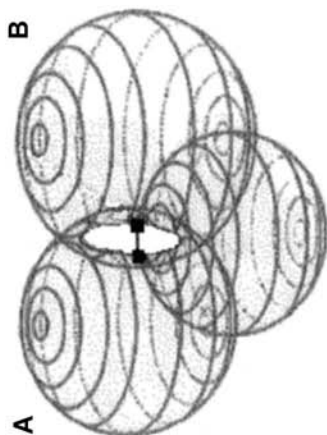

THREE MEASUREMENTS FROM THREE SATELLITES PUT THE LOCATION AT ONE OF TWO POINTS ON THE CIRCLE THAT IS FORMED BY THE INTERSECTION OF TWO SPHERES.

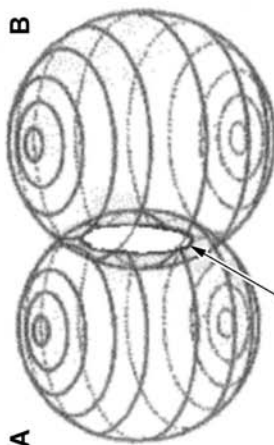

TWO MEASUREMENTS FROM TWO SATELLITES PUT THE LOCATION SOMEWHERE ON THE CIRCLE THAT IS FORMED BY THE INTERSECTION OF TWO SPHERES.

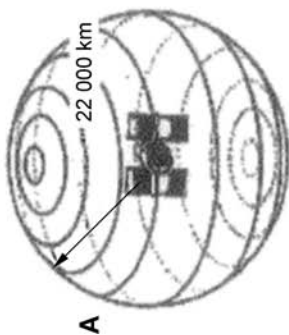

PRECISE POSITIONING OF ANY OBJECT IN THREE DIMENSIONAL SPACE

Canadian Forces, *Maps, Field Sketching, Compasses and the Global Positioning System*, Department of National Defence (p. 86)

Figure 15Z-1 Trilateration

THIS PAGE INTENTIONALLY LEFT BLANK

## GPS SATELLITES

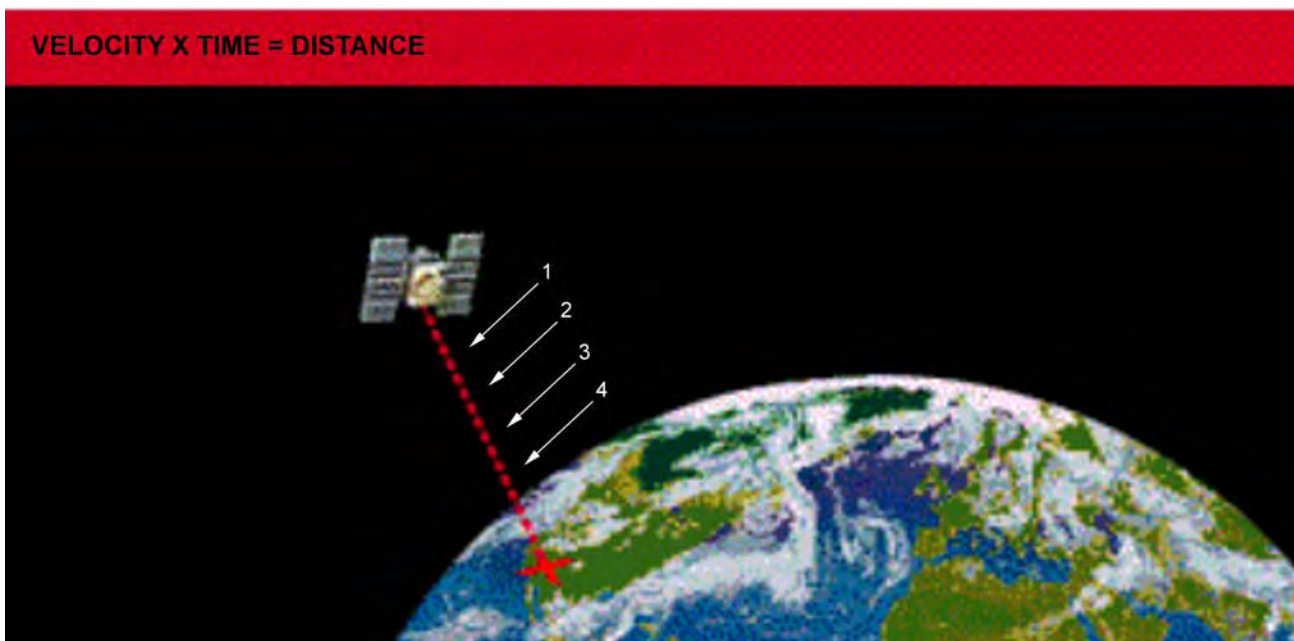

*"GPS Tutorial", Trimble Navigation Limited, 2008, How GPS Works? Copyright 2008 by Trimble Navigation Limited. Retrieved April 11, 2008, from <http://www.trimble.com/gps/howgps-triangulating.shtml>*

Figure 15AA-1 Travelling Down

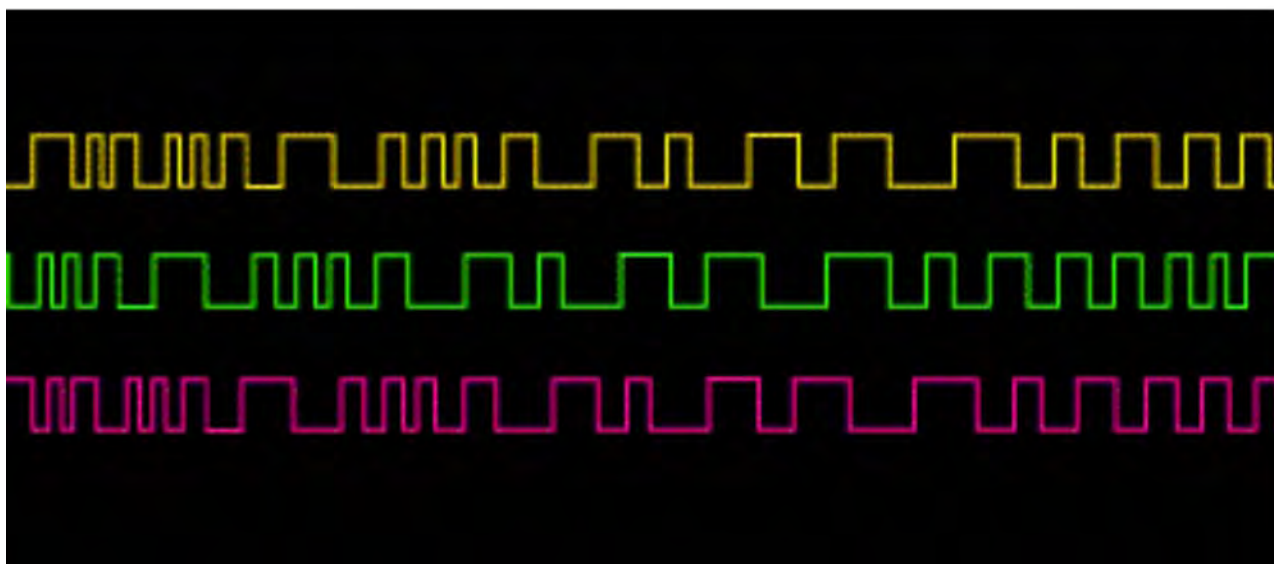

*"GPS Tutorial", Trimble Navigation Limited, 2008, How GPS Works? Copyright 2008 by Trimble Navigation Limited. Retrieved April 11, 2008, from <http://www.trimble.com/gps/howgps-triangulating.shtml>*

Figure 15AA-2 Coded Signals

# **THE CHALLENGE OF TIMING**

**Timing is tricky.**

**Precise clocks are needed to  
measure travel time.**

**The travel time from a satellite  
directly overhead is about  
0.06 seconds.**

**The time required to synchronize the  
receiver's internal coded pulses with  
the satellite's coded pulses is equal  
to the travel time.**



*"GPS Control Segment", Millennium Telecomm Corp (MTC), Control Stations, Copyright 2007 by Phoenix Tree Technology Corp. Retrieved April 15, 2008, from <http://ufindit.com/GPS-stations.asp>*

Figure 15AA-3 GPS Control and Monitoring Stations

THIS PAGE INTENTIONALLY LEFT BLANK



**THE MERIDIAN LINE LASER, OLD ROYAL OBSERVATORY, GREENWICH**

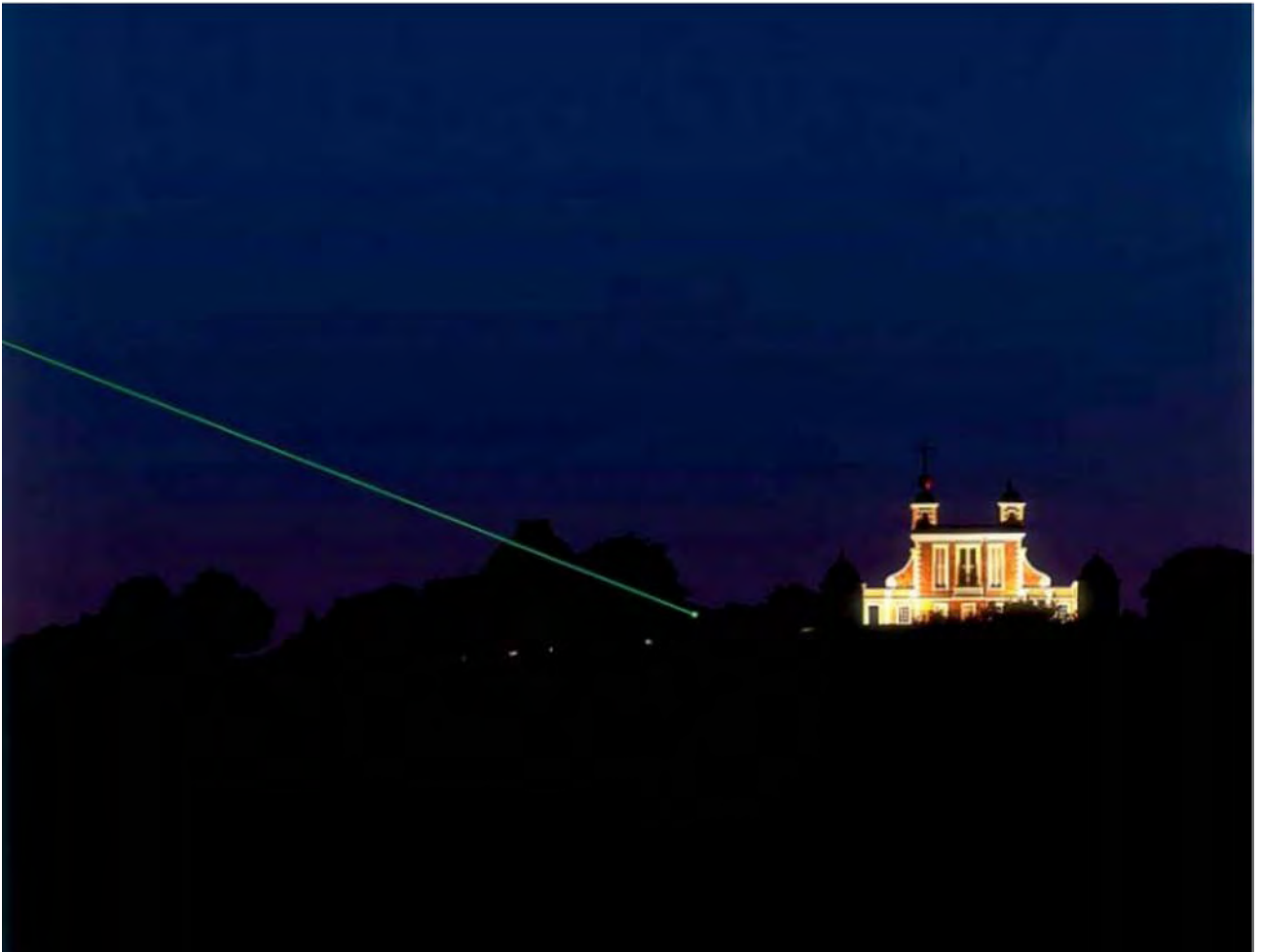

*NMM Royal Observatory, 2008, Meridian Line. Retrieved April 11, 2008, from <http://www.nmm.ac.uk/server/show/nav.2904>*

Figure 15AB-1 The Meridian Line Laser, Old Royal Observatory, Greenwich

THIS PAGE INTENTIONALLY LEFT BLANK

**SPACE SHUTTLE *ENDEAVOUR* (STS-118) AFTER UNDOCKING FROM THE ISS**



*National Aeronautical and Space Administration, STS-118 Build the Station, Build the Future, NASA (p. 54)*

Figure 15AC-1 Space Shuttle *Endeavour* (STS-118) After Undocking From the ISS

THIS PAGE INTENTIONALLY LEFT BLANK

## SKYVIEW



NASA SkyView, 2008, "SkyView: The Internet's Virtual Telescope".  
Retrieved March 19, 2008, from <http://skyview.gsfc.nasa.gov/>

Figure 15AD-1 SkyView Home Page

**SkyView**  
The Internet's Virtual Telescope  
[Home](#) [Query Form](#) [Help](#)

## SkyView Query Form

[Access Previous SkyView Interfaces](#)  
[Access Static Non-JavaScript Query Form](#)

Initiate request:    [Display results in new window](#)

**Required Parameters:**

**Coordinates or Source:**   
(e.g. "Eta Carinae", "10 45 3.6, -59 41 4.2", or "161.265, -59.685" [omit the quotes])

**Surveys:** Select at least one survey

**SkyView Surveys**

Gamma Ray:	X-ray:	EUVE:	Optical:	Infrared:	Radio:
COMPTEL EGRET (3D) EGRET <100 MeV EGRET >100 MeV	PSPC 2.0 Deg-Inten GRANAT/SIGMA Flux GRANAT/SIGMA HEAO 1 A-2 HRI INTEGRAL/SPI GC PSPC 1.0 Deg-Inten	EUVE 83 A EUVE 171 A EUVE 405 A EUVE 555 A ROSAT WFC F1 ROSAT WFC F2	DSS DSS1 Blue DSS1 Red DSS2 Blue DSS2 IR DSS2 Red H-Alpha Comp	2MASS-J 2MASS-H 2MASS-K COBE DIRBE (OLD) COBE DIRBE/AAM COBE DIRBE/ZSMA IRAS 12 micron	0408MHz 1420Mhz (Bonn) CO GB 6 (4850Mhz) NVSS SUMSS 843 Mhz VLA FIRST (1.4 Ghz)

---

**Common Options** (coordinate system, projection, image size)

**Coordinates:**  J2000  Special Coordinates  (e.g. J2100, B1975)

**Projection:**

**Image size (pixels):**  **Image Size (degrees):**

[Use 4-byte floating point values for FITS file](#)

Initiate request:

---

**Other Options** (resampling, scaling, color tables, etc)

---

**Overlays** (grid, catalogs, RGB image, contours)

---

**3-D Image Surveys**

NASA SkyView, 2008, "SkyView: The Internet's Virtual Telescope".  
Retrieved March 19, 2008, from <http://skyview.gsfc.nasa.gov/>

Figure 15AD-2 SkyView Query Form



## SkyView Images

### Digitized Sky Survey: Original Digitized Sky Survey



X, Y: 273,3 -> J2000.0: 12 00 09.78 -01 10 10.0

**Image color table:** 

**Image scaling:** Log, values range from 4406.0 to 18483.0

**Image size(degrees):** 0.14166666 x 0.14166666

**Image size(pixels):** 300 x 300

**Requested Center:** NGC 4030

**Coordinate System:** J2000.0

**Map projection:** TanProjecter

*NASA SkyView, 2008, "SkyView: The Internet's Virtual Telescope".  
Retrieved March 19, 2008, from <http://skyview.gsfc.nasa.gov/>*

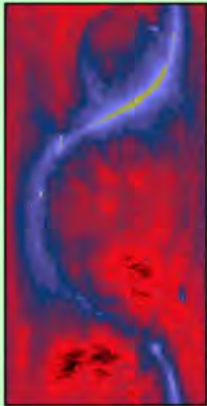

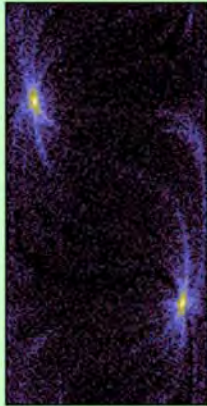
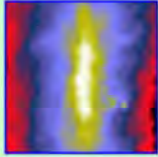

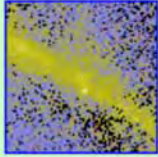
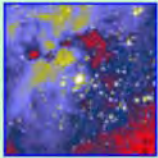

Figure 15AD-3 SkyView Image



## Non-Astronomer Page

This page introduces SkyView to the non-astronomer. We hope that after reading this page you can use SkyView to explore the sky. Earlier versions of this page included a specialized interface, but that tended to hide many of the capabilities of SkyView and so here we discuss how you can use our standard web interface. You can produce all sky images, or images of a small region of the sky using SkyView. A few examples...

**Some images created using SkyView**

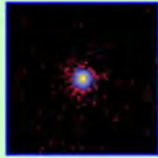
 All-sky image in radio waves	 All-sky image in X ray light
 All-sky image in extreme UV light	 <a href="#">Galactic Center</a> Center of Milkyway infrared
 <a href="#">Andromeda</a> Galaxy optical	 <a href="#">Geminga, Crab</a> Pulsars gamma-ray
 <a href="#">Eta Carinae</a> Star optical	 <a href="#">IC 443</a> Supernova x-ray
 <a href="#">Cygnus X-1</a> Black Hole x-ray	

NASA SkyView, 2008, "SkyView: The Internet's Virtual Telescope".  
Retrieved March 19, 2008, from <http://skyview.gsfc.nasa.gov/>

Figure 15AD-4 SkyView Non-Astronomers Page



SKY-MAP.ORG

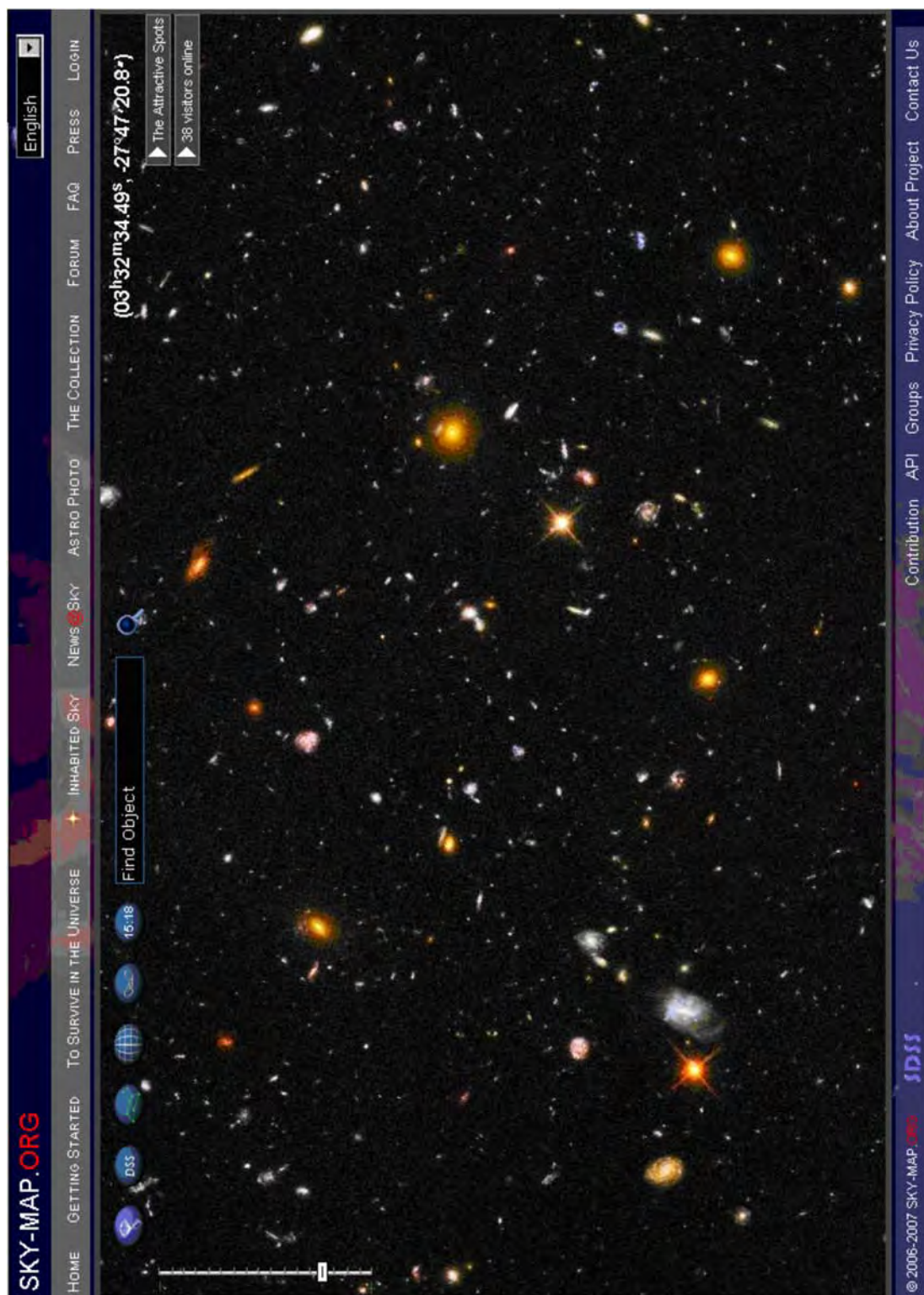

SKY-MAP.ORG, 2008, "SKY-MAP.ORG". Retrieved March 19, 2008, from <http://sky-map.org/>

Figure 15AE-1 The View From the Hubble Space Telescope

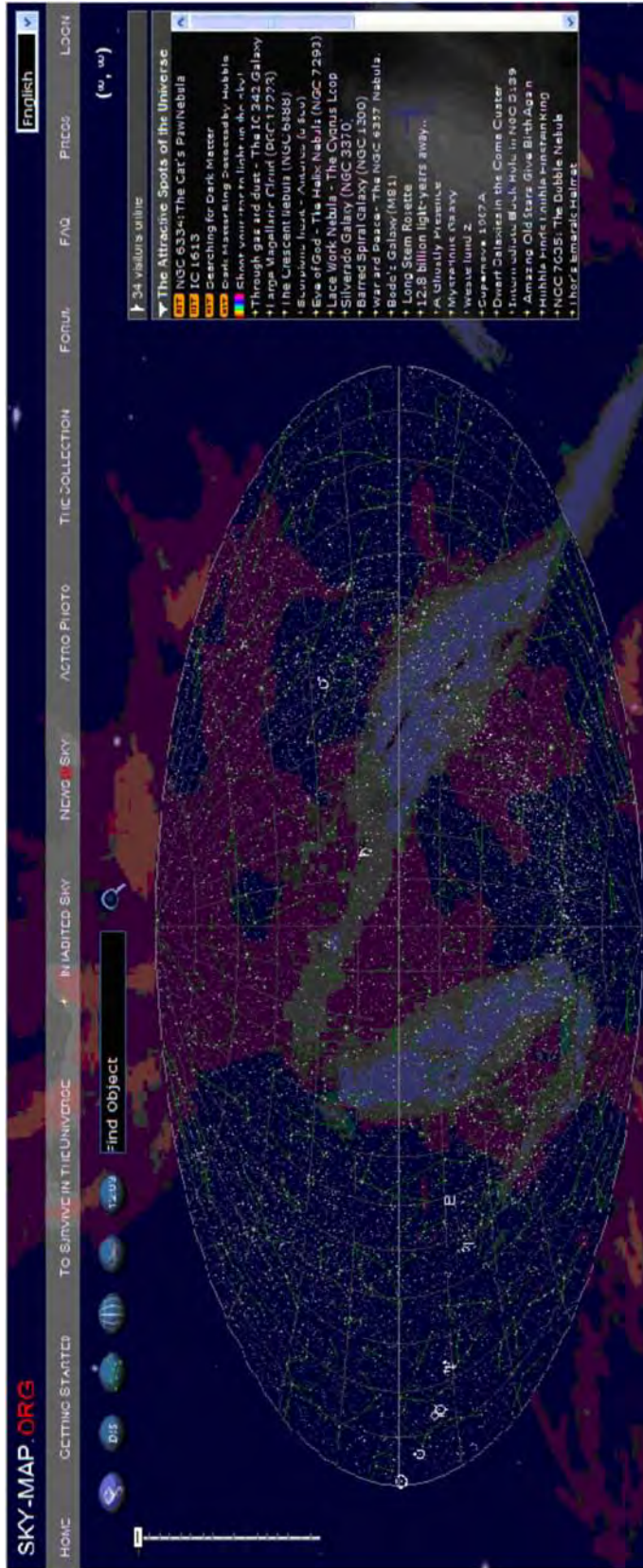

SKY-MAP.ORG, 2008, "SKY-MAP.ORG". Retrieved March 19, 2008, from <http://sky-map.org/>

Figure 15AE-2 SKY-MAP.ORG Home Page

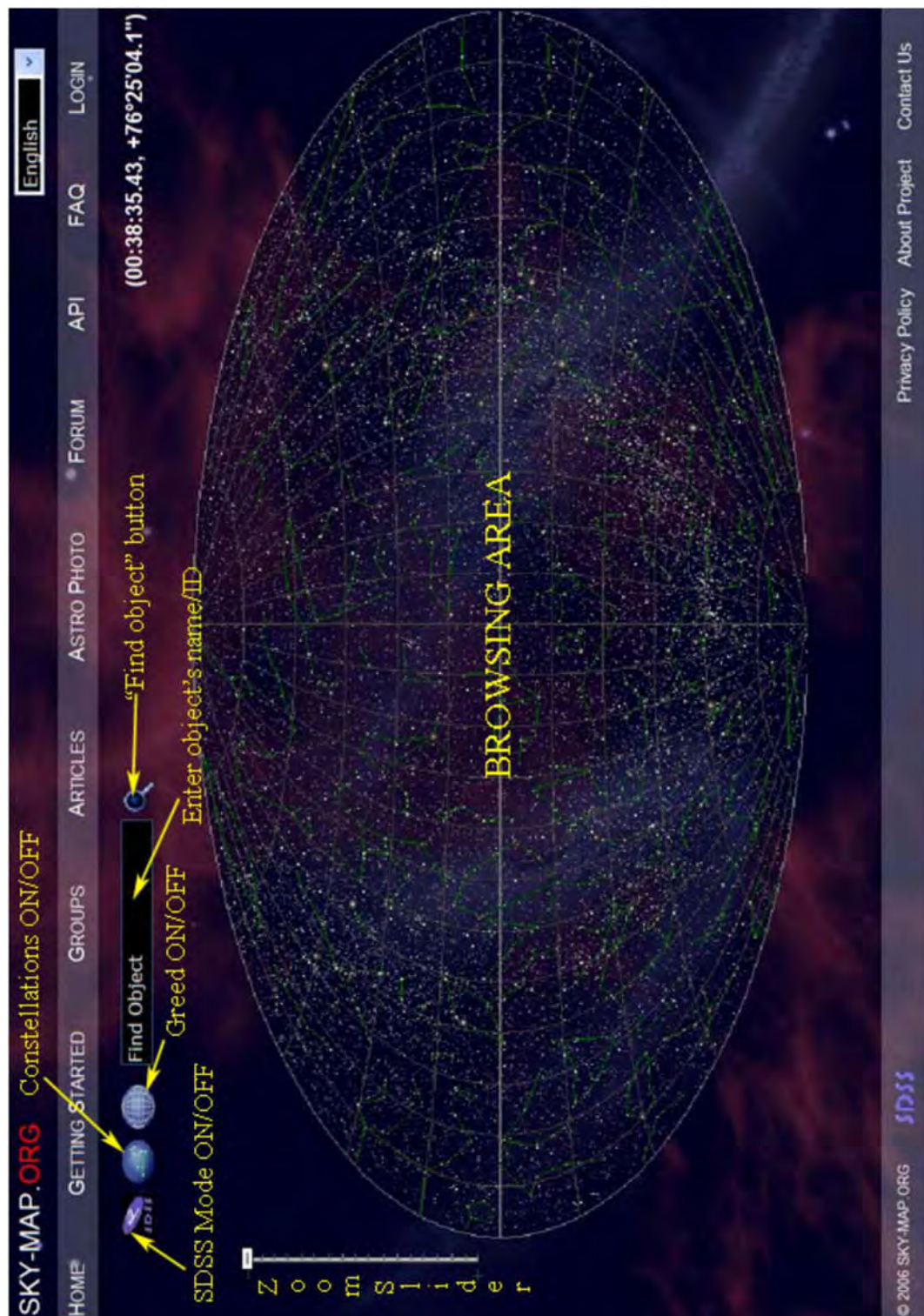

SKY-MAP.ORG, 2008, "SKY-MAP.ORG". Retrieved March 19, 2008, from <http://sky-map.org/>

Figure 15AE-3 SKY-MAP.ORG Instruction Page

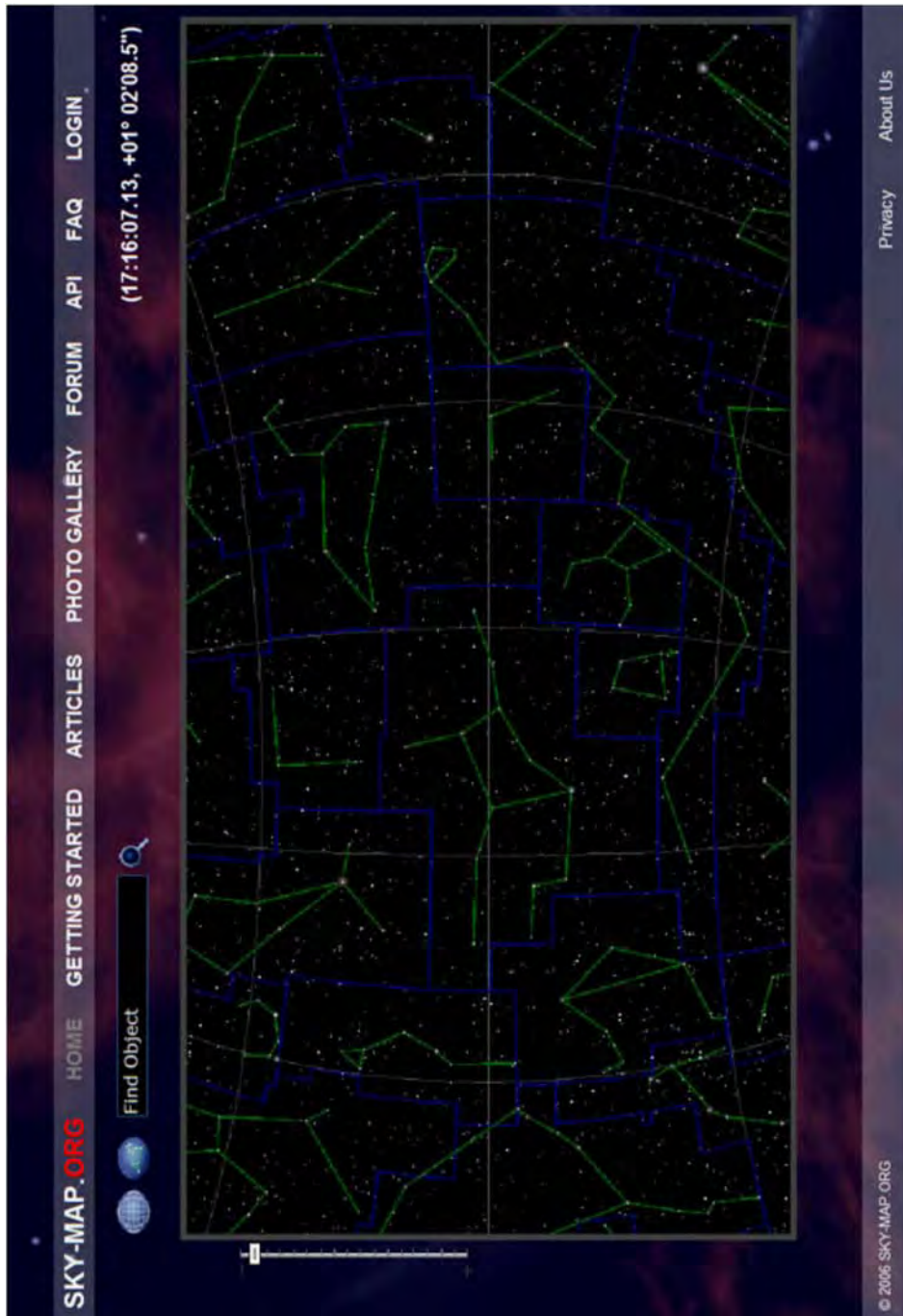

SKY-MAP.ORG, 2008, "SKY-MAP.ORG". Retrieved March 19, 2008, from <http://sky-map.org/>

Figure 15AE-4 SKY-MAP.ORG Normal Mode

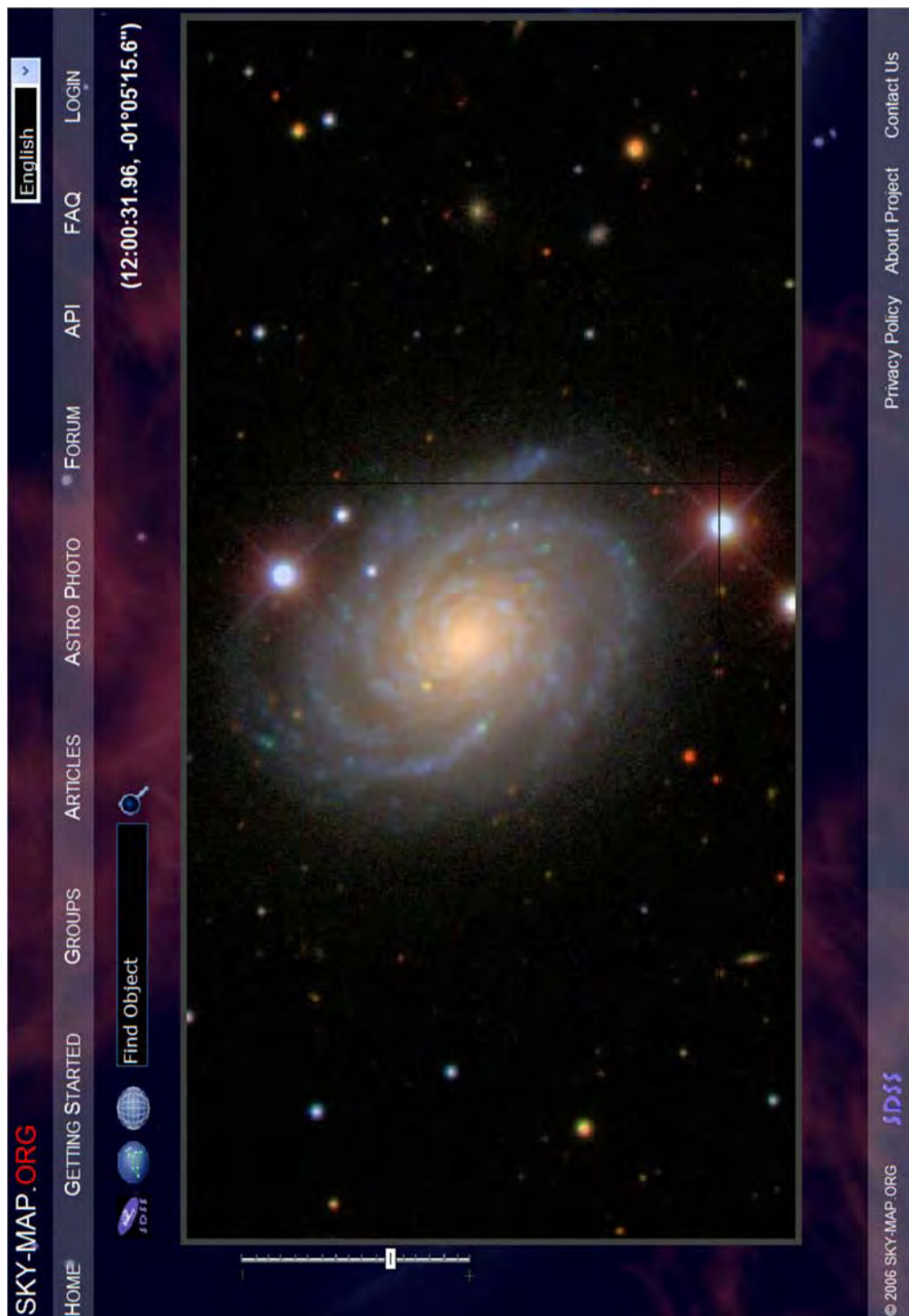

SKY-MAP.ORG, 2008, "SKY-MAP.ORG". Retrieved March 19, 2008, from <http://sky-map.org/>

Figure 15AE-5 Spiral Galaxy in SDSS Mode

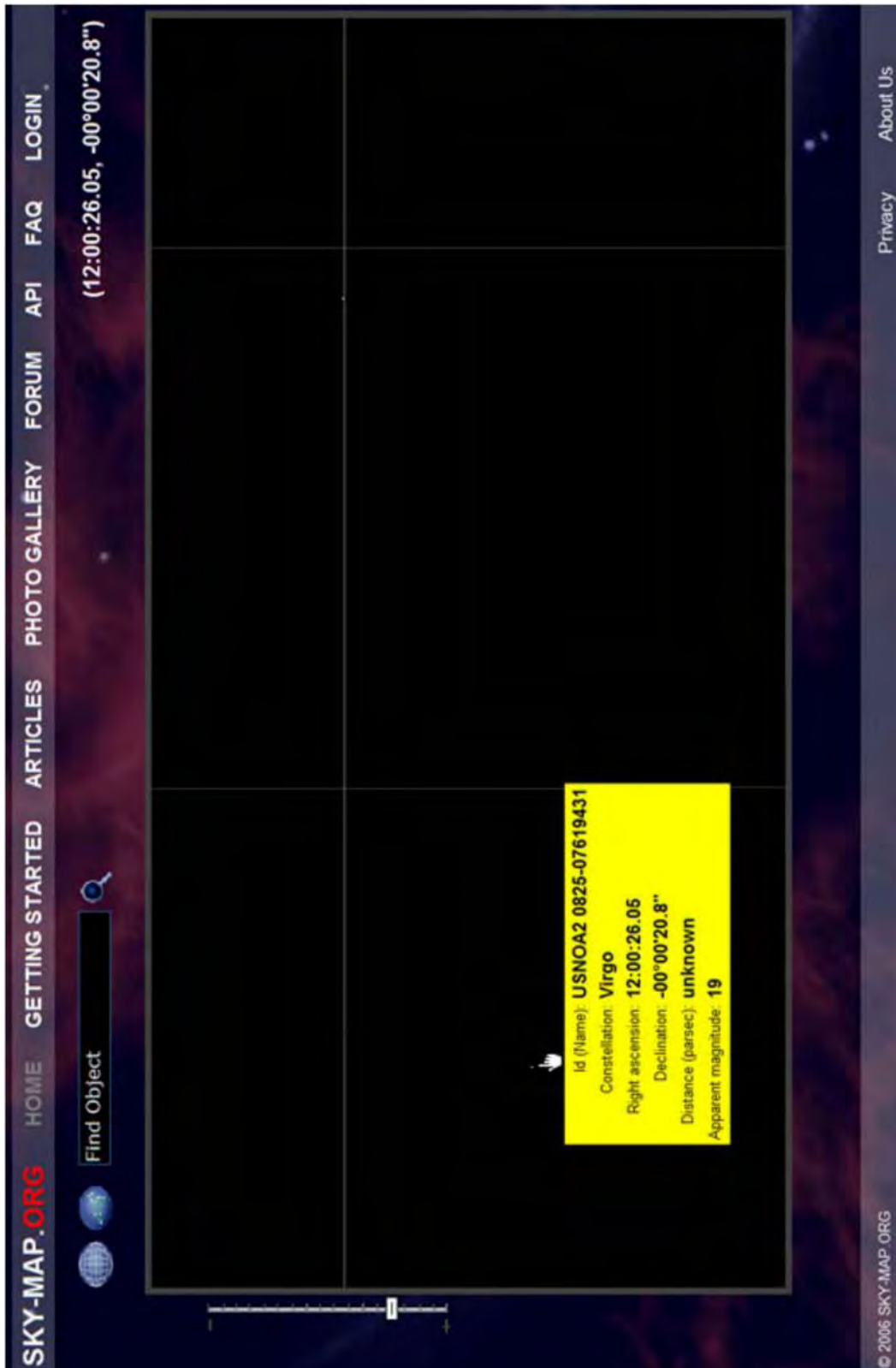

SKY-MAP.ORG, 2006, "SKY-MAP.ORG". Retrieved March 19, 2008, from <http://sky-map.org/>

Figure 15AE-6 Magnitude 19 in Virgo

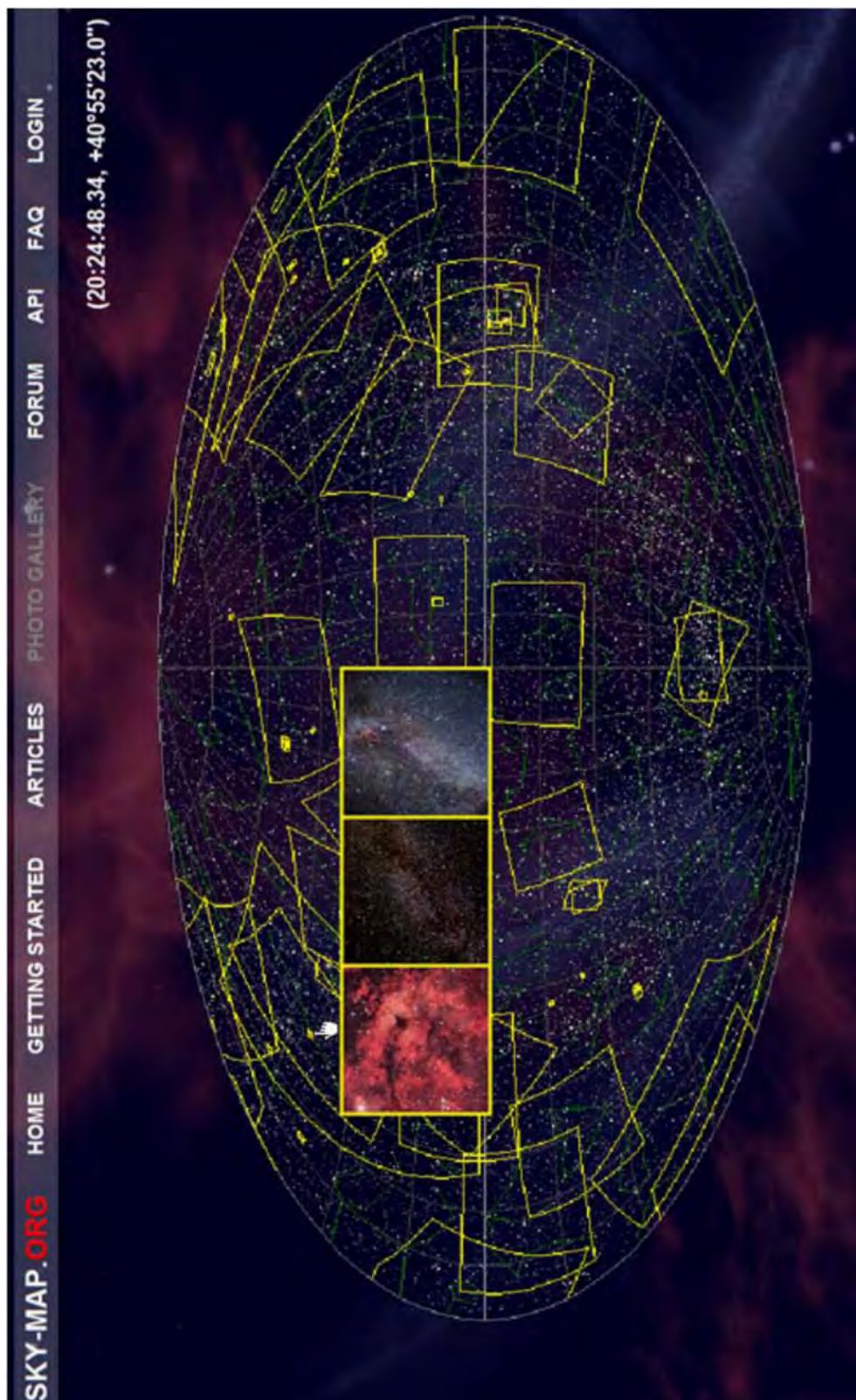

SKY-MAP.ORG, 2006, "SKY-MAP.ORG". Retrieved March 19, 2008, from <http://sky-map.org/>

Figure 15AE-7 SKY-MAP.ORG Photo Gallery

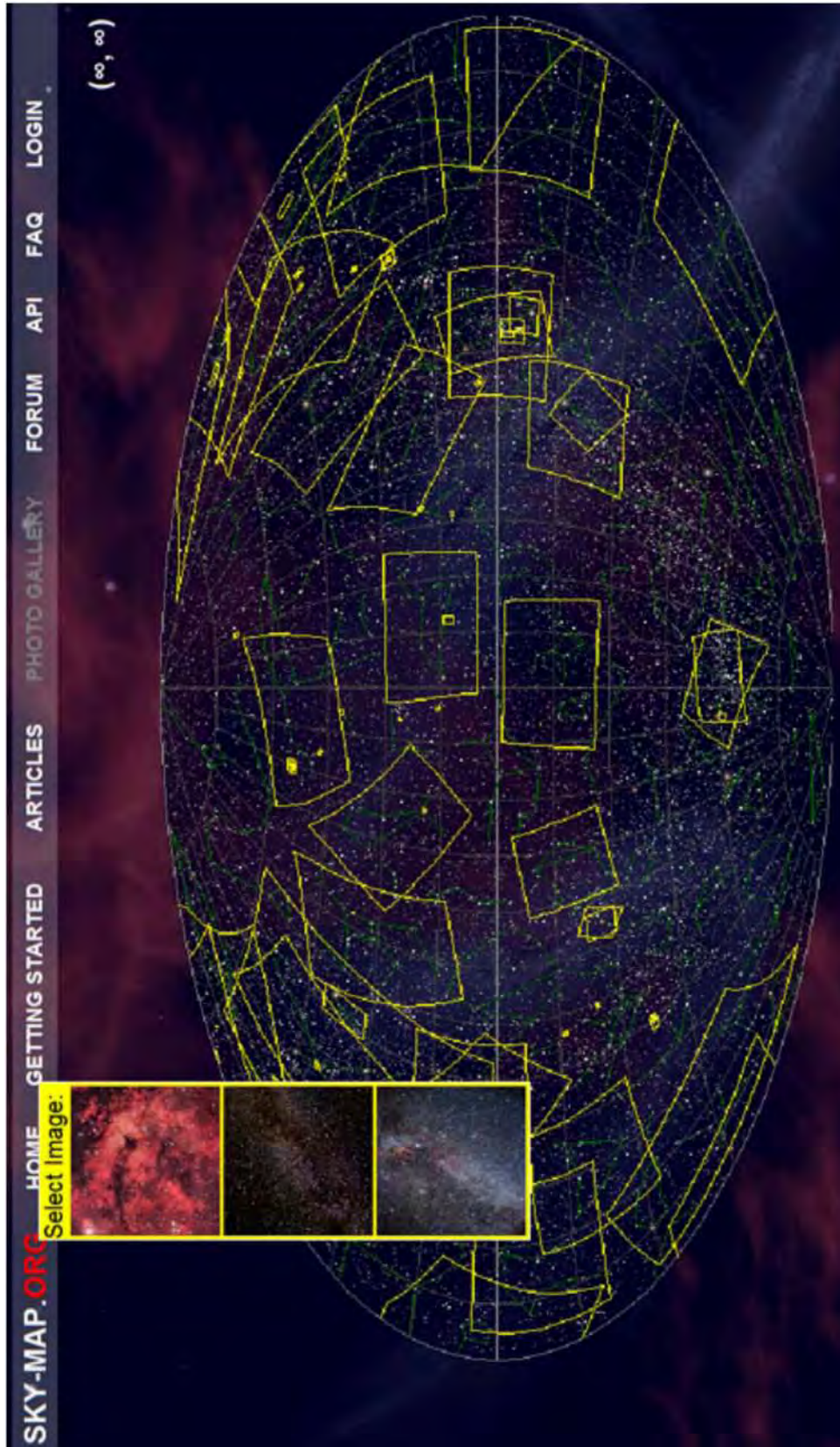

SKY-MAP.ORG, 2006, "SKY-MAP.ORG". Retrieved March 19, 2008, from <http://sky-map.org/>

Figure 15AE-8 Image Selection





SKY-MAP.ORG, 2006, "SKY-MAP.ORG". Retrieved March 19, 2008, from <http://sky-map.org/>

Figure 15AE-9 Gamma Cygni Nebula Image Selected

THIS PAGE INTENTIONALLY LEFT BLANK

## ASTRONOMY BASICS

For background information regarding many aspects of astronomy, Canada's National Research Council (NRC) Herzberg Institute of Astrophysics (NRC-HIA) offers Astronomy Basics at [http://hia-ihp.nrc-cnrc.gc.ca/public/astr\\_e.html](http://hia-ihp.nrc-cnrc.gc.ca/public/astr_e.html).

### Astronomy Websites of Interest

- Sloan Digital Sky Survey (SDSS) at <http://www.sdss.org/background/>
- SKY-MAP.ORG at <http://sky-map.org/>
- NASA's SkyView at <http://skyview.gsfc.nasa.gov/>
- NASA satellite sighting opportunities data at <http://spaceflight.nasa.gov/realdatasightings/>
- Explore the Night Sky with Canada's National Research Council at <http://www.nrc-cnrc.gc.ca/eng/education/astronomy/constellations/html.html>

### HINTS FROM THE LESSON EO C340.10 IDENTIFY ONLINE STARGAZING PROGRAMS

In this lesson SKY-MAP.ORG found galaxy NGC 4030 in constellation Virgo.

NGC 4030 is at celestial coordinates:

- Right ascension: 12 hours 00 minutes 23.40 seconds
- Declination: -01°06'03.0"

When online, this photographic plate can be found by entering the name NGC 4030 into the "Find Object" text box or by entering the coordinates as right ascension followed by a comma and then declination.

This celestial coordinate data is entered into the "Find Object" text box as one data field: 12 00 23.40, -01 06 03.0.

If coordinates are entered, however, considerable magnification must be applied to see NGC 4030. At this scale, it is magnitude 0 in the real sky, appearing as a bright star.

Star brightness is called magnitude. The lower the magnitude, the brighter the object. The brightest star visible in the night sky is Sirius, classified as magnitude -1.

Sirius, the brightest star, is found at coordinates 06 45 08.90, -16 42 58.0 in Normal Mode.

SDSS does not yet cover this part of the sky, but many astro photos of Sirius can be located through Sirius' Basic Information Window (BIW) by clicking on Sirius when its BIW is open.

THIS PAGE INTENTIONALLY LEFT BLANK